

■ MEGOHMMETER

5070



ENGLISH

User Manual

 **AEMC**[®]
INSTRUMENTS

Owner's Record

The serial number for the Model 5070 is located outside on the front of the instrument. Please record this number and purchase date for your records.

MEGOHMMETER MODEL 5070

CATALOG #: 2130.30

SERIAL #: _____

PURCHASE DATE: _____

DISTRIBUTOR: _____

Table of Contents

1. INTRODUCTION	4
1.1 International Electrical Symbols	5
1.2 Definition of Measurement Categories	5
1.3 Receiving Your Shipment	5
1.4 Ordering Information	5
1.4.1 Accessories and Replacement Parts	6
1.5 Accessory Information	6
1.5.1 DataView® Software	6
1.5.2 Serial Printer (optional accessory)	6
2. PRODUCT FEATURES	7
2.1 Control Features	8
2.2 Display Features	10
3. SPECIFICATIONS	11
3.1 Reference Conditions	11
3.2 Voltage	11
3.3 Insulation Resistance	11
3.4 Power Supply	16
3.5 Environmental Specifications	17
3.6 Mechanical Specifications	17
3.7 Safety Specifications	17
3.8 Variations in Operating Range	18
4. SPECIAL FUNCTIONS	19
4.1 SET-UP Function	19
4.1.1 Default Configurations	19
4.1.2 Instrument Configuration Parameters	20
4.1.3 SET-UP Menu	27
4.2 MODE / PRINT Button	28
4.2.1 Primary Function - MODE	28
4.2.2 Secondary Function - PRINT	32

4.3	DISPLAY / GRAPH Button	33
4.3.1	Primary Function - DISPLAY	33
4.3.2	Secondary Function - GRAPH	46
4.4	◀ / TEMP Button	46
4.4.1	Primary Function - ◀	46
4.4.2	Secondary Function - TEMP	46
4.5	▼ / SMOOTH Button	48
4.5.1	Primary Function - ▼	48
4.5.2	Secondary Function - SMOOTH	48
4.6	▲ / ALARM Button	49
4.6.1	Primary Function - ▲	49
4.6.2	Secondary Function - ALARM	49
4.7	▶ / ☀ Button	49
4.7.1	Primary Function - ▶	49
4.7.2	Secondary Function - ☀	49
4.8	MEM / MR Button	50
4.8.1	Primary Function - MEM (Save)	50
4.8.2	Second Function - MR (Recall)	51
4.9	Clearing the Memory	52
4.10	Calculation of ΔT from Stored Data	53
4.11	Maximum Output Voltage	54
4.12	List of Error Codes	54

5. MEASUREMENT FUNCTIONS 55

5.1	AC/DC Voltage	55
5.2	Insulation Measurement	55
5.3	Capacitance Measurement	58
5.4	Residual Current Measurement	58

6. OPERATION 59

6.1	Performing Measurements	59
6.2	Step Function Mode	60
6.3	Operation Examples	63
6.4	Printing Measured Values (MODE / PRINT Button)	64

6.5	Instantaneous Printing of Measurements (Print Result).....	64
6.6	Printing Data in Memory (Print Memory).....	67
7.	DATAVIEW® SOFTWARE	71
7.1	Introduction	71
7.2	Features	71
7.3	Installing DataView®	72
7.4	Installing the USB Drivers for Each Instrument.....	75
7.5	Connecting the Model 5070 to your Computer	76
7.6	Using DataView®	76
7.6.1	Configuring the Instrument.....	77
7.6.2	Running the Test	82
7.7	DataView® Megohmmeter Templates.....	86
7.7.1	Megohmmeter Summary Report Template	86
7.7.2	Title Page.....	87
8.	MAINTENANCE	88
8.1	Recharging the Battery	88
8.2	Fuse Replacement	89
8.3	Cleaning.....	89
8.4	Storage.....	89
	APPENDIX A: UTILIZING THE GUARD TERMINAL.....	90
	APPENDIX B: SERIAL CABLE REQUIREMENTS.....	92
	APPENDIX C: V DISTURBANCE/V OUTPUT FEATURE.....	93
	Repair and Calibration.....	94
	Technical and Sales Assistance	94
	Limited Warranty	95
	Warranty Repairs.....	95





INTRODUCTION



These safety warnings are provided to ensure the safety of personnel and proper operation of the instrument.

- Do not attempt to perform any tests with these instruments until you have read the instruction manual.
- Safety is the responsibility of the operator!
- Tests are to be carried out only on non-energized circuits! Check for live circuits before making resistance measurements (Safety Check).
- High voltage is present, as is the sample connected to it. Anyone performing or assisting in testing must follow all safety precautions to prevent electrical shock to themselves and to others.
- AEMC® considers the use of rubber gloves to be an excellent safety practice, even if the equipment is properly operated and correctly grounded.
- When testing samples with a capacitive component, make sure they have been properly discharged and are safe to touch. Dielectric insulation samples should be short-circuited for at least five times the amount of time they were energized.
- Megohmmeters should never be used in an explosive environment.
- Only use the leads that are supplied with the megohmmeter. If they are defective or worn, replace before testing.
- This instrument can be used on installations rated for 1000V, Category III, or 2500V, Category I.

1.1 International Electrical Symbols

	This symbol signifies that the instrument is protected by double or reinforced insulation.
	This symbol on the instrument indicates a WARNING and that the operator must refer to the user manual for instructions before operating the instrument. In this manual, the symbol preceding instructions indicates that if the instructions are not followed, bodily injury, installation/sample and product damage may result.
	Risk of electric shock. The voltage at the parts marked with this symbol may be dangerous.
	In conformity with WEEE 2002/96/EC

1.2 Definition of Measurement Categories

- Cat. I:** For measurements on circuits not directly connected to the AC supply wall outlet such as protected secondaries, signal level, and limited energy circuits.
- Cat. II:** For measurements performed on circuits directly connected to the electrical distribution system. Examples are measurements on household appliances or portable tools.
- Cat. III:** For measurements performed in the building installation at the distribution level such as on hardwired equipment in fixed installation and circuit breakers.
- Cat. IV:** For measurements performed at the primary electrical supply (<1000V) such as on primary overcurrent protection devices, ripple control units, or meters.

1.3 Receiving Your Shipment

- Match the contents with the packing list.
- Notify your distributor of any missing items.
- If the equipment appears to be damaged, file a claim immediately with the carrier and notify your distributor at once.



NOTE: Charge the instrument fully before use.



1.4 Ordering Information

Megohmmeter Model 5070.....Cat. #2130.30
Includes soft accessory bag, one red, blue and black lead with integral hippo clips; one blue jumper lead; one RS-232 DB9 F/F 6 ft null modem cable, rechargeable battery, DataView® software, US 120V power cord and user manual.

1.4.1 Accessories and Replacement Parts

Cable, PC RS-232, DB9 F/F 6 ft Null Modem Cable	Cat. #2119.45
Replacement Cable (for Serial Printer) PC RS-232, DB9 F/F 6 ft....	Cat. #2119.46
Small Classic Tool Bag	Cat. #2133.72
Fuse, set of 5, 0.1A, 380V, 5 x 20, .10kA	Cat. #2119.84
Leads - set of 3, 10 ft color-coded - [RATED 5000V] (color-coded leads and alligator clips).....	Cat. #2119.76
Replacement leads - set of 3, 10 ft leads (JUMPER NOT INCLUDED) (1 red, 1 blue, and 1 black 10 ft lead with integral hippo clips).....	Cat. #2119.85
Leads - set of 3, 25 ft leads (JUMPER NOT INCLUDED) (1 red, 1 blue and 1 black with integral hippo clips).....	Cat. #2119.86
Leads - set of 3, 45 ft leads (JUMPER NOT INCLUDED) (1 red, 1 blue and 1 black with integral hippo clips).....	Cat. #2119.87
DPU414-30B Serial Printer (includes RS-232 6 ft cable, power supply, rechargeable battery and 5 rolls of paper).....	Cat. #2140.21
Paper, set of 5 rolls, for use with Printer DPU414-30B.....	Cat. #2140.22

Order Accessories and Replacement Parts Directly Online
Check our Storefront at www.aemc.com/store for availability

1.5 Accessory Information

1.5.1 DataView® Software

DataView® software makes it possible to:

- Retrieve data from memory and plot graphs of the changes in insulation as a function of the time over which the test voltage is applied, R(t).
- Print out protocols of personalized tests, depending on the user's needs.
- Create text files for use on spreadsheets.
- Set up and control the instrument entirely by the RS-232.

1.5.2 Serial Printer (optional accessory)

Recommended printer: SEIKO (EPSON): DPU414 - DPU411 - DPU41

This serial printer (**Cat. #2140.21**) comes with a PC RS-232, DB9 F/F 6 ft cable, power supply, rechargeable battery and 5 rolls of paper.

PRODUCT FEATURES

The Model 5070 megohmmeter is a top-of-the-line measuring instrument, portable, in a rugged housing with a graphic display. It is capable of operating from internal battery or line power.

Main Functions:

- Automatic detection and measurement of voltage/frequency/input current
- Quantitative and qualitative insulation measurement
 - Measurement at 500/1000/2500/5000V_{DC} or other test voltage between 40 and 5100V_{DC} (adjustable voltage)
 - Measurement in voltage step mode (the applied voltage increases in steps)
 - Automatic calculation of DAR/PI and DD (dielectric discharge index) quality ratios
 - Automatic calculation of measurement result referred to a reference temperature
- Automatic capacitance measurement
- Automatic measurement of residual current

This megohmmeter helps ensure the safety of electrical installations and equipment. The operation is controlled by a microprocessor for data acquisition, processing, and display of measurements and the storage and printing of results.

Advantages:

- Digital filtering of insulation measurements
- Automatic voltage measurement
- Automatic detection of external AC or DC voltages on the terminals, before or during insulation measurements, disabling or stopping the measurements when measurement accuracy is no longer guaranteed
- Threshold programming to trigger audible alarms
- Timer for measurement time checks
- Fuse protection of the instrument with detection and display of defective fuses
- Operator safety by automatic discharge of residual high voltage on the equipment tested

- Automatic shutdown of the instrument to save battery power
- Battery charge indication
- Large backlit graphic display that is very easy to read
- Memory (128KB), real time clock, and serial interface
- Control and programming of the instrument from a PC (using DataView® software)
- Direct printing with a serial printer (optional accessory - Cat. #2140.21)

2.1 Control Features

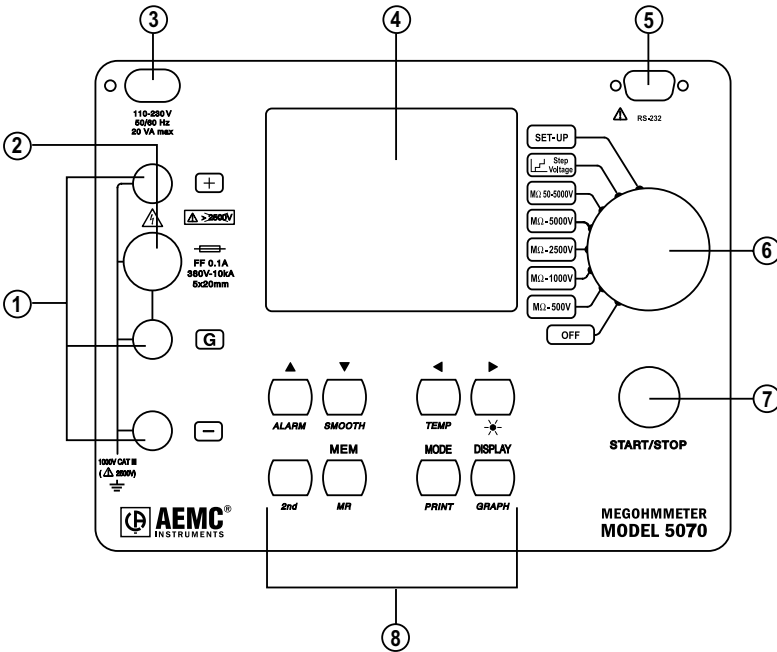

1. Safety terminals: “+”, “G” and “-”
2. Protective fuse access
3. AC power plug (direct operation on AC and battery recharge)
4. Back-lit liquid crystal display
5. RS-232 serial interface male plug (9-pin)
 - For connection to a PC or printer
6. Rotary selector switch with 8 positions:
 - **OFF** - Instrument is off

- **MΩ - 500V** - Insulation measurement (to 2TΩ)
- **MΩ - 1000V** - Insulation measurement (to 4TΩ)
- **MΩ - 2500V** - Insulation measurement (to 10TΩ)
- **MΩ - 5000V** - Insulation measurement (to 10TΩ)
- **MΩ 50V - 5000V** - Insulation measurement with selectable test voltage (from 40V to 5100V: 10V steps from 40V to 1000V and 100V steps 1000V to 5000V)
- **Step Voltage** - Insulation measurement with voltage step function (up to 5 steps can be configured)
- **SET-UP** - User programming of the megohmmeter configuration

7. START/STOP button (starts and stops measurements)

8. Eight buttons, each with a primary and secondary function. The secondary functions are highlighted in yellow italics below each button:

- **2nd** (*yellow button*) - Selects the second function on each button.
- **▲** - Selects a function or increments the parameter on which the cursor is positioned. Pressing and holding the key increases the rate of change of the parameter.
ALARM - Activates or deactivates the alarms programmed in SET-UP.
- **▼** - Selects a function or decrements the parameter on which the cursor is positioned. Pressing and holding the key increases the rate of change of the parameter.
SMOOTH - Stops/starts smoothing of displayed values during testing.
- **◀** - Selects a parameter to be modified to the left.
TEMP - activates temperature correction of the measurement to the reference temperature programmed in SET-UP.
- **▶** - Selects a parameter to be modified to the right.
- **☀** - Turns the display backlight ON or OFF.
- **MEM** - Saves measured values.
MR - Recalls saved data.
- **MODE** - Before starting a test, the mode function allows selection of run time, sample rate, DAR PI and ratio times.
PRINT - direct printing of test result(s) on a serial or parallel printer.
- **DISPLAY** - Browses through the various screens accessible before, during and after the measurement.
- **GRAPH** - After a “timed run”, the Graph mode displays insulation resistance versus time in a graph format.

2.2 Display Features

REMOTE Indicates that the instrument is controlled remotely via the RS-232 interface. In this mode, all of the keys and the rotary switch are inactive, except for the OFF position.

COM Flashes when data is transmitted to the serial interface. On continuously if there is a problem in transmission.

2nd Indicates that the secondary function of a key will be used.



Indicates that the “programmed time test” mode was selected before the measurement was started.

DAR Indicates that the “automatic calculation of Dielectric Absorption Ratio” mode was selected before the measurement was started.

PI Indicates that the “automatic calculation of Polarization Index” mode was selected before the measurement was started.

DD Indicates that the “automatic calculation of “Dielectric Discharge Index” mode was selected before the measurement was started.

SMOOTH Smooths the insulation measurement readings on the display for better visibility.

ALARM Indicates that the alarm is activated. An audible alarm will sound if the value measured is above the limit defined in the SET-UP mode.



Indicates the battery charge condition.



Voltage generated dangerous, $V > 120V_{DC}$.



External voltage present - this symbol is activated when the Start button is pressed if $V > 25V_{RMS}$.

SPECIFICATIONS

3.1 Reference Conditions

Influence Quantity	Reference Values
Temperature	23°C ± 3°K
Relative Humidity	45 to 55%
Supply Voltage	9 to 12V
Frequency Range	DC and 15.3 to 65Hz
Capacitance in parallel with the input resistance	0µF
Electric Field	nil
Magnetic Field	<40A/m

3.2 Voltage

Measurement Range	1.0 to 99.9V	100 to 999V	1000 to 2500V	2501 to 5100V
Frequency Range*	DC and 15Hz to 500Hz			DC Only
Resolution	0.1V	1V	2V	2V
Accuracy	1% of Reading ± 5cts		1% of Reading ± 3ct	
Input Impedance	750kΩ at 3MΩ depending on measure voltage			

*Over 500Hz, the small display indicates “- - -” and the main display gives only an assessment of the peak value of the measured voltage.

Measurement Category: 1000V Cat. III or 2500V Cat. I (transients ≤2.5kV)

3.3 Insulation Resistance

Method: Voltage-current method according to EN 61557-2 (ed. 02/97)

Nominal Output Voltage: 500, 1000, 2500, 5000 VDC (or selectable from 40V to 5100V)

Adjustments Available in Variable Mode: 10V from 40V to 1000V
100V from 1000V to 5100V

Open-circuit Voltage: ≤1.1 × V_n ±2V (V_n ±2% in variable mode)

Max. Overload of Voltage V_n: (1.05 + dISt) V_n + 50V
with dISt = 3%, 10% or 20%

NOTE: V_n = Test Voltage

Nominal Current: >1mADC

Short-circuit Current: <1.6mA ± 5%

Load Current: 3mADC approx when starting measurement

Maximum Acceptable AC Voltage:

V_{peak} - (1.05 + dISt) V_n with dISt = 3%, 10% or 20%

NOTE: dISt is the ratio of V Disturbance/V Output and is selectable in SET-UP mode

Measurement Ranges:

500V: 30kΩ to 1.999TΩ 2500V: 100kΩ to 9.99TΩ

1000V: 100kΩ to 3.999TΩ 5000V: 300kΩ to 9.99TΩ

Variable: 40V to 5100V (see graph below)

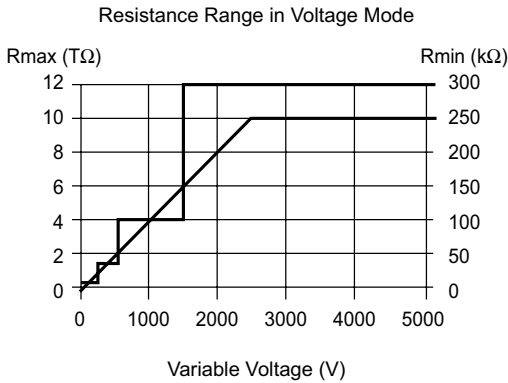

Resolution and Accuracy Chart (see curves - pages 14 and 15)

Test Voltage	500V	500V - 1000V 2500V	500V - 1000V - 2500V - 5000V			
Range	30 to 99kΩ	100 to 299kΩ	300 to 999kΩ	1MΩ to 3.999MΩ	4.00 to 39.99MΩ	40.0 to 399.9MΩ
Resolution	1kΩ				10kΩ	100kΩ
Accuracy	±5% of Reading + 3cts					

Test Voltage	500V - 1000V - 2500V - 5000V				1000V - 2500V 5000V	2500V 5000V
Range	400MΩ to 3.999GΩ	4.00 to 39.99GΩ	40.0 to 399.9GΩ	400GΩ to 1.999TΩ	2.000 to 3.999TΩ	4.00 to 10.00TΩ
Resolution	1MΩ	10MΩ	100MΩ	1GΩ		10GΩ
Accuracy	±5% of Reading + 3cts			±15% of Reading + 10cts		

DC Voltage Measurement (during insulation test):

Range	Resolution	Accuracy
40.0 to 99.9V	0.1V	1% of Reading \pm 1ct
100 to 1500V	1V	
1501 to 5100V	2V	

DC Voltage Measurement (after insulation test):

Range	Resolution	Accuracy
25 to 5100V	0.2% Vn	5% of Reading \pm 3cts

Typical build-up time for the measurement according to components tested ($V_{dist} = 0.03V_n$).

These values include the influences caused by the charge of the capacitive component, by the automatic range system and to the test voltage control.

Test Voltage	Load	Non Capacitive (unsmoothed measurement)	With capacitance of 1 μ F (smoothed measurement)
500V	1M Ω	3s	4s
	100G Ω	8s	40s
1000V	1M Ω	3s	4s
	100G Ω	8s	80s
2500V	3M Ω	3s	4s
	100G Ω	8s	90s
5000V	5M Ω	4s	16s
	100G Ω	8s	120s

Typical discharge time for a capacitive component to reach 25Vdc.

Initial Voltage	500V	1000V	2500V	5000V
Discharge time (C in μ F)	C x 3s	C x 4s	C x 4s	C x 7s

Typical changes in test voltages as a function of the load:

500V Range

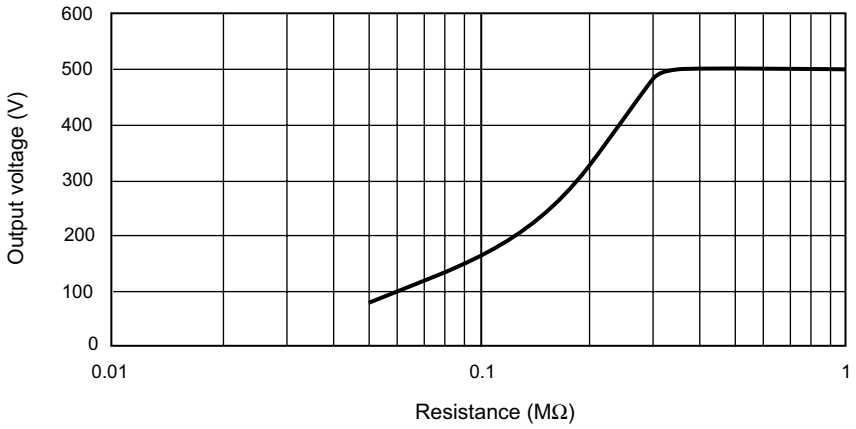

1000V Range



2500V Range



5000V Range

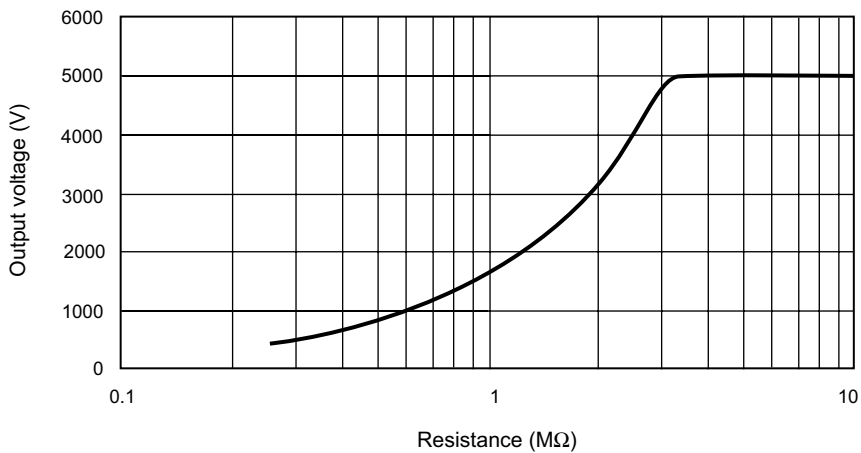

Capacity Measurement (after discharge of tested component):

Range	Resolution	Accuracy
0.005 to 9.999 μ F	1nF	10% of Reading \pm 1ct
10.00 to 49.99 μ F	10nF	

Leakage Current Measurement

Range	Resolution	Accuracy
0.000 to 0.250nA	1pA	15% of Reading \pm 10cts
0.251 to 9.999nA		10% of Reading
10.00 to 99.99nA	10pA	5% of Reading
100.0 to 999.9nA	100pA	
1.000 to 9.999 μ A	1nA	
10.00 to 99.99 μ A	10nA	
100.0 to 999.9 μ A	100nA	
1000 to 3000 μ A	1 μ A	10% of Reading

Calculation of Terms DAR and PI

Range	Resolution	Accuracy
0.02 to 50.00	0.01	5% of Reading \pm 1ct

Calculation of Term DD

Range	Resolution	Accuracy
0.02 to 50.00	0.01	10% of Reading \pm 1ct

3.4 Power Supply

- Rechargeable battery NiMh (8 x 1.2V / 3.5Ah)
- Recharge: 85 to 256V / 50-60Hz

Minimum Battery Charge Life (per NF EN 61557-2)

Test Voltage	Nominal Charge	Number of Measurements 5s on nominal charge (with 25s pause between each measurement)
500V	500k Ω	6500
1000V	1M Ω	5500
2500V	2.5M Ω	4000
5000V	5M Ω	1500

Average Battery Life: The operating time will be 15 days or 3 weeks, based upon a 10 minute long PI measurement.

Recharge Time:

6 hours for 100% capacity (10 hours if the battery is completely drained)

0.5 hours for 10% capacity (charge life: 2 days approximately)



NOTE: It is possible to recharge the batteries while performing insulation measurements provided that the values measured are higher than $20M\Omega$. In this case, the recharging time is higher than 6 hours and depends on the frequency of the measurements.

3.5 Environmental Specifications

Operating Range:

14° to 104°F (-10° to 40°C) during recharging of batteries

14° to 131°F (-10° to 55°C) during measurement

10 to 80% RH

Storage: -40° to 158°F (-40° to 70°C); 10 to 90% RH

Altitude: <2000m

3.6 Mechanical Specifications

Case Dimensions (LxWxH):

10.63 x 9.84 x 7.09" (270 x 250 x 180mm)

Weight: 9.5 lbs (4.3kg) approx

3.7 Safety Specifications

Electrical safety according to EN 61010-1 (Ed. 2 for 2001),

EN 61557 (ed. 97)



Double insulation:

1000V Cat. III, Pollution Degree 2

2500V Cat. I

Electromagnetic Compatibility:

NF EN 61326-1 (Ed. 97) + A1, industrial environment category

Mechanical Protection:

IP 53 per NF EN 60529 (Ed. 92)

IK 04 per NF EN 50102 (Ed. 95)

3.8 Variations in Operating Range

Influential Quantity	Range of Influence	Quantity Influenced*	Influence	
			Typical	Max
Battery Voltage	9V to 12V	V MΩ	<1ct <1ct	2cts 3cts
Temperature	-10° to +55°C	V MΩ	0.15% R/10°C 0.20% R	0.3% R ± 1ct 1% R ± 1ct
Humidity	10 to 80% RH	V MΩ (10kΩ to 40GΩ) MΩ (40GΩ to 10TΩ)	0.2% R 0.2% R 3% R	1% R ± 2cts 1% R ± 5cts 15% R ± 5cts
Frequency	15 to 500Hz	V	0.3% R	0.5% R ± 1ct
AC voltage superimposed on test voltage	0% to 20% Vn	MΩ	0.1% R / % Vn	0.1% R / % Vn ± 5cts

*The terms DAR, PI, DD and the capacity and current leak measurements are included in the quantity "MΩ".

SPECIAL FUNCTIONS

4.1 SET-UP Function

This function, located at the top rotary switch position (Blue “SET-UP” position), is used to change the configuration of the instrument.

4.1.1 Default Configurations

The default configurations are as follows:

SET-UP	
Instr.Nr. 9600004	SW Version 1.2
<input checked="" type="checkbox"/> Display contrast	80
Alarm Settings	
Adjustable Voltage 1	50V
Adjustable Voltage 2	100V
Adjustable Voltage 3	250V
Timed Run (h:m)	0:10
Sample Time (m:s)	0:10
DAR (s/s)	30/60
PI (m/m)	1.0/10
Set Step Function 1	
Set Step Function 2	
Set Step Function 3	
Temperature Unit	Celsius
Default probe temperature	23°C
Rc reference temperature	40°C
ΔT for R/2	10°C
Calculate ΔT from Memory	
Maximum Output Voltage	5100V
Set Default Parameter	
Clear Memory	
V Disturbance / V Output	3%
Buzzer	on
Power Down	off
Baud Rate	9600 / RS232
Units	Europe
Date (d.m.y)	04.02.2004
Time (h:m)	15:47

4.1.2 Instrument Configuration Parameters

DISPLAY CONTRAST

This function allows you to change the lightness and darkness of the display to best suit the environment.

Range
0 to 255*

*The display is no longer legible above 130

To adjust the contrast, press the ► button to move the blinking cursor to the display contrast value. The default value is 80. Use the ▲ and ▼ buttons to lighten or darken the display. The higher the number the lighter the display will be. When finished press the ◀ button to move the cursor back to the parameter selection position.

ALARM SETTINGS

This function allows you to select a low insulation resistance value that will cause an alarm symbol to appear on the display and will cause the buzzer to emit a continuous tone when the measured insulation resistance falls below this value.

Voltage	Range
500V	30kΩ to 2TΩ
1000V	100kΩ to 4TΩ
2500V	300kΩ to 10TΩ
5000V	
Adj. Voltage 1	10kΩ to 10TΩ
Adj. Voltage 2	
Adj. Voltage 3	

To adjust the alarm settings, press the ▼ button until the blinking cursor is to the left of alarm settings. To adjust the alarm value press the ► button. From the screen displayed, you can adjust low limit resistance values for 500V, 1000V, 2500V, 5000V or the three adjustable voltage positions.

To change the low limit for any of these voltage positions, use the ▲ and ▼ buttons to select the voltage, then press the ► button to highlight the resistance value for that voltage. Next, use the ▲ and ▼ buttons to increase or decrease the value at the blinking cursor position.

Once the desired resistance value has been programmed, press the ◀ button to move the cursor again to the voltage selection part of the screen. You may now select the different voltage and adjust its value as just described.

To exit the alarm setting function, press the **DISPLAY** button. This will bring you back to the top of the SET-UP menu.

ADJUSTABLE VOLTAGE 1, 2, 3

This function defines a specific voltage that will be used for Insulation Resistance Measurement when the rotary switch is in the adjustable voltage position.

The values for this setting can be anywhere from 40 to 5100 Volts adjustable in 10 or 100 Volt increments.

Voltage	Range
Adj. Voltage 1	40 to 5100V (in steps of 10V from 40 to 1000V) (in steps of 100V from 1000 to 5100V)
Adj. Voltage 2	
Adj. Voltage 3	

There are three adjustable settings possible.

To change the value for Adjustable Voltage 1, 2 or 3, use the ▼ button. To select the Adjustable Voltage parameter to program, press the ► button to highlight the voltage to be used for that selection, then use the ▲ and ▼ buttons to increment or decrement the value.

When the desired voltage is on screen, press the ◀ button to move the cursor back to the parameter selection position.

TIMED RUN (h : m)

This function lets you set a time from 1 minute to 49 hours and 59 minutes to run an insulation resistance test.

The Model 5070 will automatically end the test at the end of the timed run.

Range
00 to 49 : 01 to 59

To change the length of time that a test will run, press the ► button to move the blinking cursor to the hour in TIMED-RUN. Use the ▲ and ▼ buttons to increment or decrement the hours. Next, press the ► to select the minute value. Use the ▲ and ▼ buttons to increment or decrement the minutes.

When finished, press the ◀ button to move the cursor back to the parameter selection position.

SAMPLE TIME (m : s)

Data from a timed run test can be stored in the Model 5070 at an interval you select. This storage interval can be as fast as once every 5 seconds to as slow as once every 10 minutes.

Range
00 to 59 : 05 to 59

DAR (s : s)

The Dielectric Absorption Ratio is a ratio of insulation resistance measured at two predetermined times. The reading at the first time mark is then divided into the reading at the second time mark to calculate the ratio. The typical times used for this test are 30 seconds and 60 seconds. These are the factory default settings. You can adjust the times here in the set up mode from 10 to 90 seconds for the first reading and from 15 to 180 seconds for the second reading, both in 5 second increments.



NOTE: The Model 5070 will not allow the time for the second reading to be set lower than the set time for the first reading.

Range
10 to 90 : 15 to 180

PI (m : m)

The Polarization Index is a ratio of insulation resistance measured at two re-determined times. The reading at the first time mark is then divided into the reading at the second time mark to calculate the ratio. The typical times used for this test are 1 minute and 10 minutes. These are the factory default settings. The insulation materials used today require less time to determine this ratio. Therefore, you can adjust the times here in the set up mode to suit your needs from 0.5 minutes to 30 minutes for the first reading and from 1 minute to 90 minutes for the second reading.



NOTE: The Model 5070 will not allow the time for the second reading to be set lower than the set time for the first reading.

Range
0.5 to 30 : 1 to 90

SET STEP FUNCTION 1, 2, 3

Step voltage testing can be a valuable tool in determining defective insulation or used to dry out cables that have been penetrated by moisture.

With this function, you can program three different profiles each containing up to 5 voltage steps and dwell times from 1 minute to 9 hours and 59 minutes per step.

Step Function	Default Value		Range	
	Voltage	Duration (h:m)	Voltage	Duration (h:m)
Step Function 1		h : m		h : m
Step 1	50V	00:01	40 to 5100V (in 10V, then 100V steps)	00 to 09 : 01 to 59
Step 2	100V	00:01		00 to 09 : 01 to 59
Step 3	150V	00:01		00 to 09 : 01 to 59
Step 4	200V	00:01		00 to 09 : 01 to 59
Step 5	250V	00:01		00 to 09 : 01 to 59
	sample time	00:01 (m:s)		00 to 59 : 00 to 59*
Step Function 2		h : m		h : m
Step 1	100V	00:01	40 to 5100V (in 10V, then 100V steps)	00 to 09 : 01 to 59
Step 2	300V	00:01		00 to 09 : 01 to 59
Step 3	500V	00:01		00 to 09 : 01 to 59
Step 4	700V	00:01		00 to 09 : 01 to 59
Step 5	900V	00:01		00 to 09 : 01 to 59
	sample time	00:01 (m:s)		00 to 59 : 00 to 59*
Step Function 3		h : m		h : m
Step 1	1000V	00:01	40 to 5100V (in 10V, then 100V steps)	00 to 09 : 01 to 59
Step 2	2000V	00:01		00 to 09 : 01 to 59
Step 3	3000V	00:01		00 to 09 : 01 to 59
Step 4	4000V	00:01		00 to 09 : 01 to 59
Step 5	5000V	00:01		00 to 09 : 01 to 59
	sample time	00:01 (m:s)		00 to 59 : 00 to 59*

*The minimum sample time is related to the total duration of the test (Total Run Time). It is equal to : Sample Time (seconds) = (h+1)*5 where h= total run time in hours.

TEMPERATURE UNIT

This function toggles the display between Fahrenheit and Celsius scales for temperature display.

Range
°C or °F

DEFAULT PROBE TEMPERATURE

With this function, you can program a default value for the temperature of the device under test. This will be used when temperature correction is applied if no value is programmed right after the test is conducted.

Range
-15°C to +75°C

Rc REFERENCE TEMPERATURE

Reference temperature to which the measurement result must be referred.

Range
-15°C to +75°C

ΔT for R/2

Insulation resistance changes with temperature. The typical rule of thumb is that for every 10°C increase in temperature the leakage current doubles and the resistance halves. Some materials have a different rate of change. This feature lets you program the temperature change (ΔT) at which the resistance halves for the equipment you will be testing. This value will be used when correcting results to a reference temperature.

Range
-15°C to +75°C

CALCULATE ΔT FROM MEMORY

The Model 5070 has the ability to calculate ΔT from three previously stored test results at different temperatures from one material in the event that no ΔT is selected for the present test.

MAXIMUM OUTPUT VOLTAGE

The Model 5070 provides the ability to limit the maximum test voltage to a value you specify from 40 to 5100 volts. When programmed, the instrument will not generate a higher voltage to conduct the test even if the switch position indicates a higher voltage. For example, if you set the maximum voltage to 1250 volts and you place the rotary switch in the 5000 volt position and start a test, the Model 5070 will only output 1250 volts.

Range
40 to 5100V

SET DEFAULT PARAMETER

This function allows you to reset all the user programmable functions back to the factory defaults.

CLEAR MEMORY

The clear memory function allows you to selectively erase individual tests or all tests from the internal memory of the instrument. A warning will appear first to ensure that you don't do this by accident.

V DISTURBANCE / V OUTPUT

This ratio defines the maximum allowable disturbance voltage depending on the selected measurement voltage. If the V Disturbance exceeds the value of the ratio, the instrument stops the test in process. If the voltage exceeding the ratio is present at the device under test before the test is started, a test will not be allowed to start. Three programmable values are: 3%, 10% and 20% of the measurement voltage. The default is 3%.

Example: If a test is to be performed at 1000V and the V Disturbance / V Output is set at 10%, the presence of 100 volts ($1000V * 10\% = 100$) before the test starts will inhibit the test.

Range
3%, 10% or 20%

BUZZER

The Model 5070 is equipped with a buzzer that will emit an audible tone when a key is pressed, at regular intervals during a timed test, or will be on continuously during an alarm trip. This function lets you toggle the buzzer on or off.

Range
ON or OFF

POWER DOWN

The Model 5070 has a power save feature which turns the unit's display off after 5 minutes of no activity, if a timed test is not in progress. This function lets you toggle this feature on or off.

Range
ON or OFF

BAUD RATE

This function lets you program in the communication speed between the Model 5070 and your computer. It also lets you select a parallel communication mode for direct printing.

Press the down arrow ▼ button until the blinking cursor is to the left of Baud Rate. To adjust the baud rate, press the right arrow ► button to highlight the current setting. Next, press the up ▲ or down ▼ arrow buttons to select the desired baud rate. Your choices are 300, 600, 1200, 2400, 4800, 9600 or parallel. Press the right arrow ► button after you have selected the baud rate to complete the process.

Range
300 to 9600 / RS-232 or – / Parallel

UNITS

The Model 5070 can display the date in either US (m.d.y) or European (d.m.y) fashion. This choice can be toggled here.

Press the down arrow ▼ button until the blinking cursor is to the left of Units. To select the desired format, press the right arrow ► button to highlight the current setting. Next, press the up ▲ or down ▼ arrow buttons to select either USA or Europe. Press the right arrow ► button after you have selected the desired units to complete the process.

Range
Europe or USA

DATE

The day, month and year value can be set with this function.

Press the down arrow ▼ button until the blinking cursor is to the left of Date.

To adjust the Date, press the right arrow ► button to highlight the current setting. The cursor will move to the first variable (day for European format or month for US format).

Next, press the up ▲ or down ▼ arrow buttons to select the desired value. Press the right arrow ► button to highlight the next date field (month for European format or day for US format).

Next, press the up ▲ or down ▼ arrow buttons to select the desired value. Press the right arrow ► button once more to highlight the last date field, which is year. Press the up ▲ or down ▼ arrow buttons to select the desired year. Finally, press the right arrow ► button after you have selected the date set up to complete the process.

Europe	USA
dd.mm.yyyy	mm.dd.yyyy

TIME (h:m)

Time can be set here. A 24-hour clock is used in the Model 5070. Therefore 3:30pm would be programmed in as 15:30.

Press the down arrow ▼ button until the blinking cursor is to the left of Time. To adjust the Time, press the right arrow ► button to highlight the current setting. The cursor will move to the hour selection. Next, press the up ▲ or down ▼ arrow buttons to select the desired hour from 0 to 24. Press the right arrow ► button again to highlight minutes. Next, press the up ▲ or down ▼ arrow buttons to select the desired minutes from 0 to 59. Finally, press the right arrow ► button after you have selected the time set up to complete the process.

4.1.3 SET-UP Menu

Turning the rotary switch to SET-UP gives you access to the menu of all programmable functions. Select the function to be modified using the ▲ and ▼ buttons. Move the blinking cursor to the value to be modified using the ◀ and ▶ buttons. Adjust the value at the blinking cursor using the ▲ and ▼ buttons. Move back to the select function position by pressing the ◀ and ▶ buttons until the blinking cursor is again to the left of the function.

Pressing the **DISPLAY** button while modifying a parameter will bring you back to the top of the SET-UP menu.

When you first enter the SET-UP mode a display similar to this will appear:

SET-UP	
Instr.Nr. 9600004	SW Version 1.2
► Display contrast	80
Alarm Settings	
Adjustable Voltage 1	50V
Adjustable Voltage 2	100V
Adjustable Voltage 3	250V
Timed Run (h:m)	0:10
Sample Time (m:s)	0:10
DAR (s/s)	30/60

- The top line on this screen indicates that you are in SET-UP mode.
- Line two indicates the Model 5070's Instrument Number and Software Version.
- The selection cursor will be blinking and positioned to the left of the "Display Contrast" parameter.

To adjust the "Display Contrast" parameter, press the ► button to move the blinking cursor to display contrast value. The default value is 80. Use the ▲ and ▼ buttons to lighten or darken the display. The higher the number the lighter the display will be. When finished, press the ◀ button to move the cursor back to the parameter selection position.

The arrow buttons can be used to modify any parameter.

4.2 MODE / PRINT Button

4.2.1 Primary Function - MODE

The primary function of this button is used before the measurement takes place to define the measurement conditions.



NOTE: This button is inactive in the Step Voltage and SET-UP positions.

- Press the **MODE** button once to access the list of possible measurement modes. Select the mode using the ▲ ▼ and ◀ ▶ buttons.
- To validate the mode selected, press the **MODE** button again.

The measurement mode choices are as follows:

MANUAL STOP

This is the conventional quantitative insulation measurement mode.

The measurement is started by pressing **START/STOP** button and stopped by pressing **START/STOP** button again.

In this mode, the user determines the duration of the test, which will be indicated by the elapsed time indicator.

MODE		
Total Run Time		---
▶ Manual Stop		
Manual Stop + DD		
	Duration	Sample
	(h:m)	(m:s)
Timed Run	02:30	01:40
Timed Run + DD		
DAR (s/s)		30/60
PI (m/m)		1/10

MANUAL STOP + DD

The measurement is started by pressing **START/STOP** button and stopped by pressing **START/STOP** again.

1 minute after the end of the measurement, the instrument calculates and displays the Dielectric Discharge (DD) ratio. The time remaining during this minute is displayed.

MODE		
Total Run Time		---
Manual Stop		
▶ Manual Stop + DD		
	Duration	Sample
	(h:m)	(m:s)
Timed Run	02:30	01:40
Timed Run + DD		
DAR (s/s)		30/60
PI (m/m)		1/10

TIMED RUN

This mode is used to perform a measurement for a duration defined in advance, with a predetermined number of measurement samples. The measurement is started by pressing the **START/STOP** button and stops automatically after the time programmed by the user has occurred.

MODE		
Total Run Time		02:30:00
Manual Stop		
Manual Stop + DD		
	Duration	Sample
	(h:m)	(m:s)
▶ Timed Run	02:30	01:40
Timed Run + DD		
DAR (s/s)		30/60
PI (m/m)		1/10

This duration (Duration) and the time interval between samples (Sample) must be specified when the Timed Run mode is selected.

To set the Duration and Sample rate from the MODE screen proceed as follows:

- Use the ▲ or ▼ buttons to highlight Timed Run.
- Press the ► button to move the cursor to Duration, the hour value will be highlighted.
- Use the ▲ or ▼ buttons to select the desired hours from 0 to 49.
- Next, press the ► button to highlight minutes.
- Use the ▲ or ▼ buttons to select the desired minutes from 0 to 59.



NOTE: The minimum selectable duration is 1 minute and the maximum is 49 hours and 59 minutes.

- Press the ► button until the minute value in the sample rate is highlighted, then use the ▲ or ▼ buttons to adjust the minute value between 0 and 5.
- Next, press the ► button until the seconds value is highlighted.
- Use the ▲ or ▼ buttons to select the desired seconds from 1 to 59.



NOTE: The shortest possible sample rate is 5 seconds and the longest sample rate is 5:00 minutes.

When finished with Duration and Sample selections, press the ◀ or ► buttons again until the blinking cursor is at Timed Run.

You are now ready to begin a Timed Run Test for the selected Test Voltage.

- Press the Yellow **START/STOP** button to begin the test. The display will briefly show “OK” followed by the active test screen.
- When the measurement is started, the timer counts down showing the time remaining in the measurement.
- When the Remaining Time is zero, the measurement is stopped.

During the timed run test, the intermediate samples are automatically stored. They are used to plot a curve of insulation resistance vs time. This curve can be displayed after the measurement is completed by pressing the Yellow 2nd button and the **GRAPH** button, as long as no new measurement has been started.

The samples and the curve are automatically stored with the final value of the resistance, if it is stored.



NOTE: During the measurement, if the position of the rotary switch is changed, or the START/STOP button is pressed, the measurement is stopped.

TIMED RUN +DD

This mode is identical to the Timed Run except that 1 minute after the end of the measurement, the instrument calculates and displays the Dielectric Discharge (DD). The measurement duration is therefore the duration of timed run + 1 minute.

The insulation resistance vs time curve can be displayed after the measurement by pressing the Yellow 2nd button and the **GRAPH** button, as long as no new measurement has been started (see § 4.3.2 for a typical graph).

MODE		
Total Run Time	02:31:00	
Manual Stop		
Manual Stop + DD		
	Duration	Sample
	(h:m)	(m:s)
Timed Run	02:30	01:40
▶ Timed Run + DD		
DAR (s/s)	30/60	
PI (m/m)	1/10	

DAR

The DAR measurement is started by pressing the **START/STOP** button and stops automatically when the DAR ratio has been calculated, e.g. after 1 minute, the time taken to measure the second insulation resistance value needed for the calculation (the ratio times can be modified in the SET-UP mode). The default is 30/60 meaning the first reading will be taken in 30 seconds and the second reading will be taken in 60 seconds from the Start.

MODE		
Total Run Time	00:01:00	
Manual Stop		
Manual Stop + DD		
	Duration	Sample
	(h:m)	(m:s)
Timed Run	02:30	01:40
Timed Run + DD		
▶ DAR (s/s)	30/60	
PI (m/m)	1/10	

PI

The PI measurement is started by pressing the **START/STOP** button and stops automatically when the PI ratio has been calculated, e.g. after 10 minutes, the time taken to measure the second insulation resistance value needed for the calculation (the ratio times can be programmed in the SET-UP mode).

NOTE: In this mode, the DAR ratio will also be calculated automatically if the times needed to calculate it are less than the second time needed to calculate the PI ratio.

MODE		
Total Run Time	00:10:00	
Manual Stop		
Manual Stop + DD		
	Duration	Sample
	(h:m)	(m:s)
Timed Run	02:30	01:40
Timed Run + DD		
DAR (s/s)	30/60	
▶ PI (m/m)	1.0/10	

NOTE

1. What is the DD (Dielectric Discharge index)?

In the case of multilayer insulation, if one of the layers is defective but the resistance of all the others is high, neither the quantitative insulation measurement nor the calculation of the PI and DAR quality ratios will reveal the problem.

This makes it important to perform a dielectric discharge test, from which the DD Ratio can be calculated. This test measures the dielectric absorption of heterogeneous or multilayer insulation and disregards parallel-surface leakage currents.

It involves applying a test voltage for long enough to electrically “charge” the insulation to be measured (typically, a voltage of 500V is applied for 30 minutes).

At the end of the measurement, the instrument causes a rapid discharge, during which the capacitance of the insulation is measured; 1 minute later, the residual current circulating in the insulation is measured.

The DD Ratio is then calculated as follows:

$$\text{DD} = \frac{\text{current measured after 1 minute (mA)}}{[\text{test voltage (V)} \times \text{measured capacitance (F)}]}$$

The insulation quality rating, as a function of the value found, is as follows:

Value of DD	Quality of Insulation
DD > 7	Very Poor
DD between 7 and 4	Poor
DD between 4 and 2	Doubtful
DD < 2	Good

The dielectric discharge test is especially well-suited to insulation measurements on rotating machines, and in general, to insulation measurements on heterogeneous or multilayer insulations containing organic materials.

2. What are the DAR (Dielectric Absorption Ratio) and the PI (Polarization Indexes)?

It is beneficial to calculate insulation quality ratios, in addition to the quantitative insulation resistance value, because they can be used to eliminate the influence of certain parameters likely to invalidate the “absolute” insulation measurement.

The most important of these parameters are:

- Temperature and relative humidity with which insulation resistance varies to a quasi-exponential law.
- The leakage currents (capacitive charging current, dielectric absorption current) are created by the application of the test voltage. Even though they gradually fall off, they affect the measurement at the start for a length of time that depends on whether the insulation is in good condition or degraded.

These ratios complete the “absolute” insulation value, and reliably reflect whether the insulation layers are in good or poor condition.

In addition, changes in these ratios over time can be observed and used for preventative maintenance (e.g. to monitor the aging of the insulation of a population of rotating machines).

The DAR and PI ratios are calculated as follows:

PI = R 10 min / R 1 min

(2 values to be noted during a 10 minute measurement are at the end of 1 minute and 10 minutes)

DAR = R 1 min / R 30 sec

(2 values to be noted during a 1 minute measurement are at the end of 30 seconds and at the end of 1 minute)

Note that the times of 1 and 10 minutes for the calculation of PI and 30 & 60 seconds for the calculation of DAR are those currently considered standards and programmed as defaults in the instrument. They can be modified in SET-UP mode to adapt to a possible change in a standard or to the needs of a specific application.

Interpretation of the results:

DAR	PI	Condition of Insulation
< 1.25	< 1	Poor or even Dangerous
	< 2	
< 1.6	< 4	Good
> 1.6	> 4	Excellent

4.2.2 Secondary Function - PRINT

The secondary function of this button gives access to the print menu below.

There are two or three choices in the print mode depending on when it is accessed:

- If you access the print mode right after the completion of a test, you will see "Print result" as the first choice.
- If you access the print mode without running a test, "Print memory" will be your first choice.

Print result:

Immediate printing of a measurement following a measurement or after access to the MR (Memory Recall) mode.

Print memory:

Printing of stored data.

Baud rate / Port:

Display of baud rate selected in the SET-UP menu.

PRINT	
<input checked="" type="checkbox"/>	Print result
<input type="checkbox"/>	Print memory
Baud rate / Port	9600 / RS232

4.3 DISPLAY / GRAPH Button

4.3.1 Primary Function - DISPLAY

The primary function of this button is used to browse through the various screens of information available before, during or after the measurement. The screens vary depending on the mode selected before the measurement is started.

This section, starting on the following page, shows typical screens that can be displayed for each test mode.

MANUAL STOP mode

BEFORE the measurement:

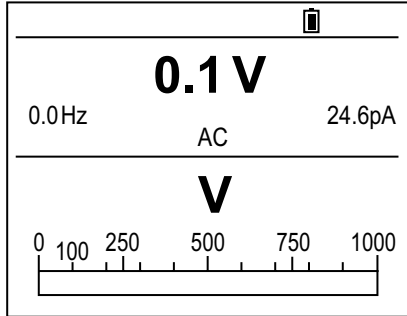
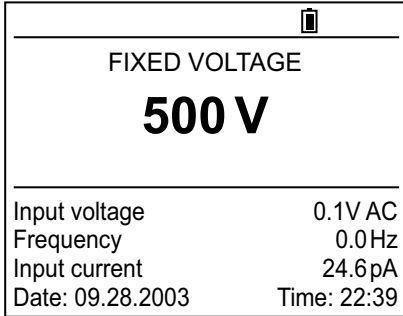

Information Displayed:	
Test type	
DC test voltage	
AC/DC input voltage	
Frequency	
Residual input current	
Date and Time	

Information after pressing DISPLAY:	
AC/DC input voltage	
Frequency	
Residual input current	
Voltage bargraph	

DURING the measurement:

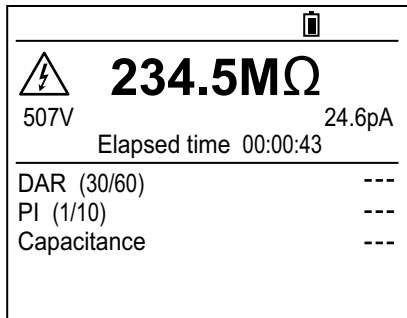
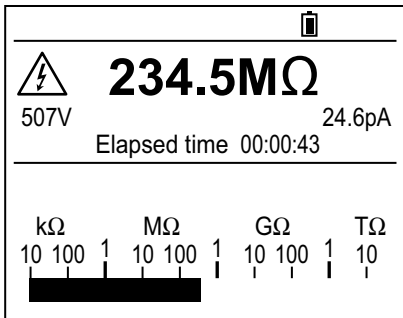

Information Displayed:	
Measured resistance	
DC test voltage	
Residual current	
Measurement duration	
Insulation resistance bargraph	

Information after pressing DISPLAY:	
Measured resistance	
DC test voltage	
Residual current	
Measurement duration	
DAR, PI, Capacitance	

AFTER the measurement:

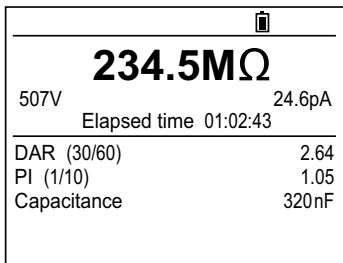

Information Displayed:

Measured resistance
DC test voltage
Leakage current
Measurement duration
DAR, PI, Capacitance values

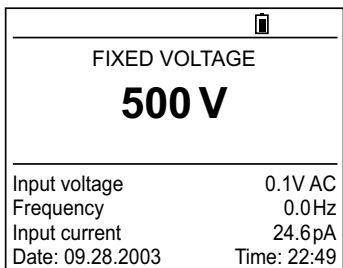

After 1st Press on DISPLAY:

Test type and test voltage
AC/DC input voltage
Frequency
Leakage current
Date, time

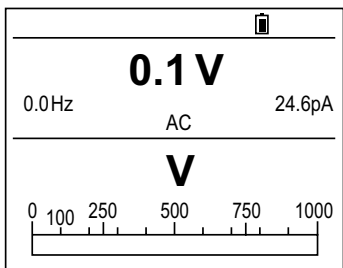

After 2nd Press on Display:

AC/DC input voltage
Frequency
Leakage current
Voltage bargraph

MANUAL STOP + DD mode

BEFORE the measurement:

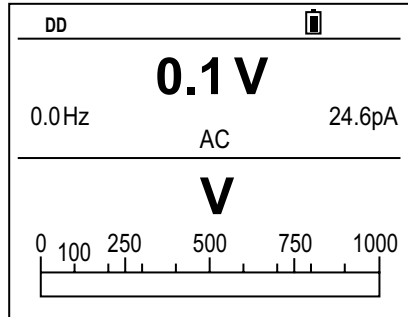
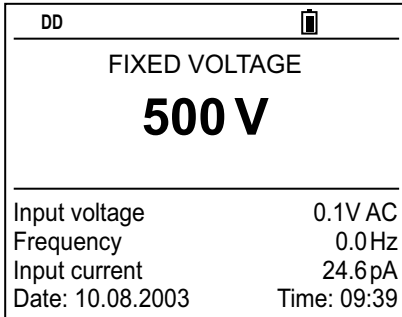

Information Displayed:
Test Type DC test voltage AC/DC input voltage Frequency Residual current Date, time

Information after pressing DISPLAY:
AC/DC input voltage Frequency Leakage current Voltage bargraph

DURING the measurement:

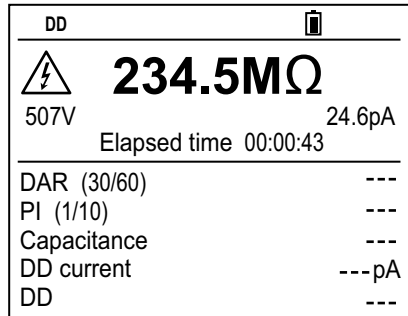
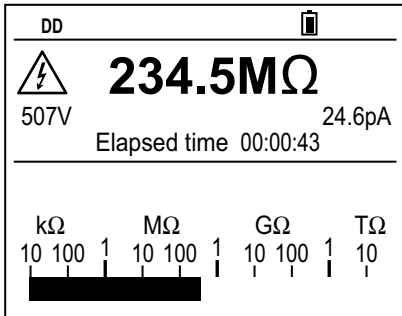

Information Displayed:
Measured resistance DC test voltage Leakage current Measurement duration Insulation resistance bargraph

Information after pressing DISPLAY:
Measured resistance DC test voltage Leakage current Measurement duration DAR, PI, Capacitance Residual current (calculation of DD) DD

AFTER the measurement:

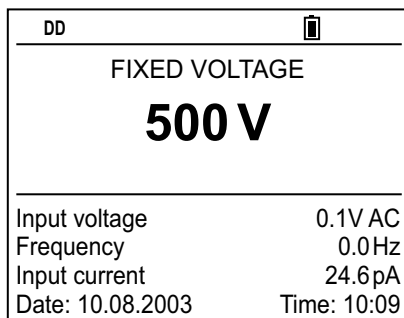
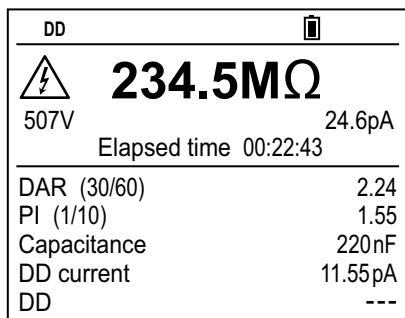

Information Displayed:	
Measured resistance	
DC test voltage	
Leakage current	
Measurement duration	
DAR, PI, Capacitance values	
Residual current (calculation of DD)	
DD	

After 1st Press on DISPLAY:	
Test Type	
DC test voltage	
AC/DC input voltage	
Frequency	
Leakage current	
Date, time	

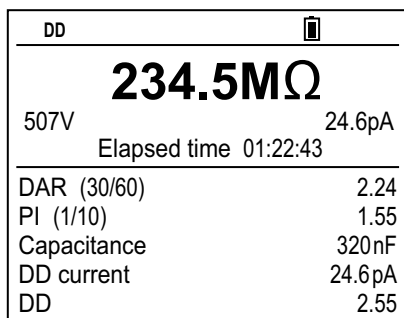
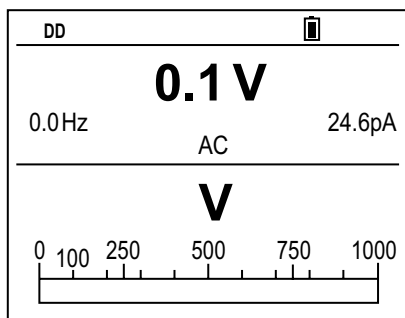

After 2nd Press on Display:	
AC/DC input voltage	
Frequency	
Leakage current	
Voltage bargraph	

After 1 Minute:	
Measured resistance	
DC test voltage	
Leakage current	
Total test time	
DAR, PI, Capacitance	
DD test current	
DD	

TIMED RUN mode

BEFORE the measurement:

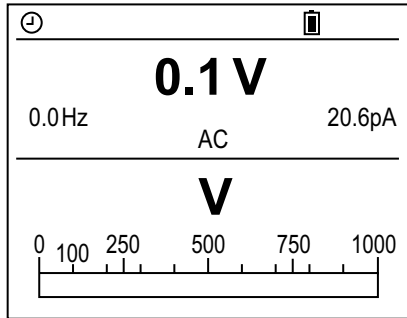
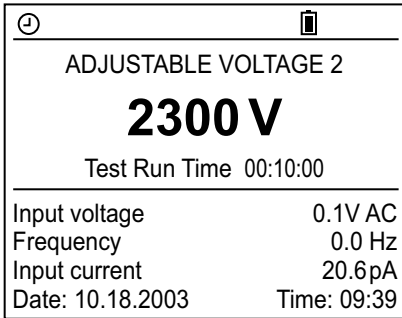

Information Displayed:	
Test type	
DC test voltage	
Programmed duration of the test	
AC/DC input voltage	
Frequency	
Residual current	
Date, time	

Information after pressing DISPLAY:	
AC/DC input voltage	
Frequency	
Residual current	
Voltage bargraph	

DURING the measurement:

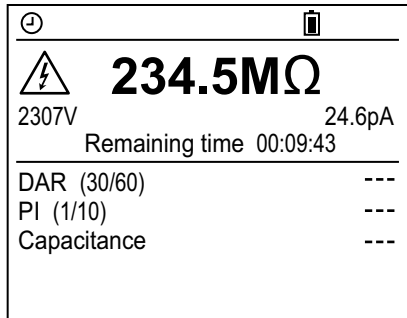
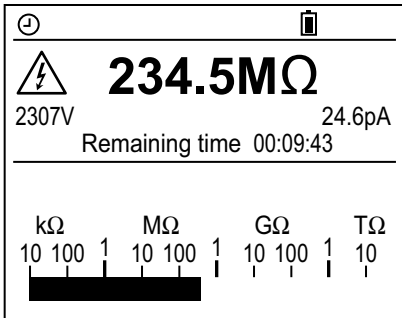

Information Displayed:	
Measured resistance	
DC test voltage	
Leakage current	
Remaining measurement time	
Insulation resistance bargraph	

Information after pressing DISPLAY:	
Measured resistance	
DC test voltage	
Leakage current	
Remaining measurement time	
DAR, PI, Capacitance	

AFTER the measurement:

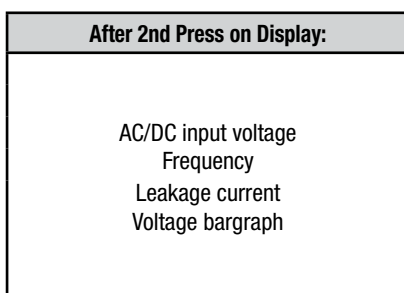
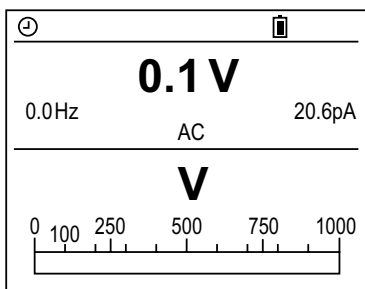
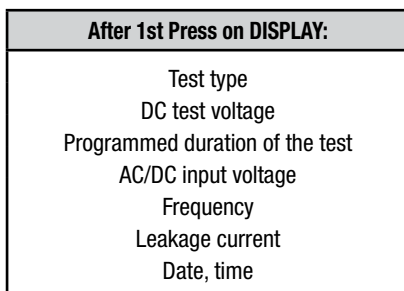
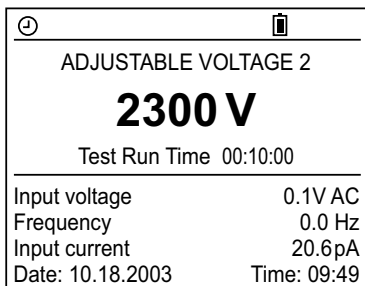
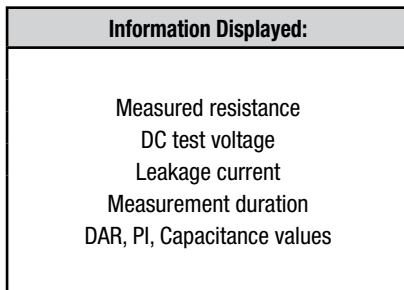
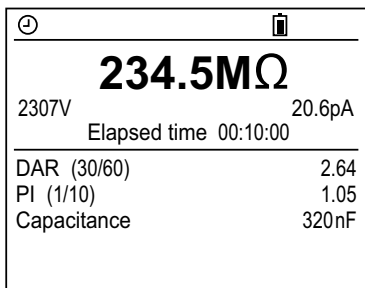

TIMED RUN + DD mode

BEFORE the measurement:

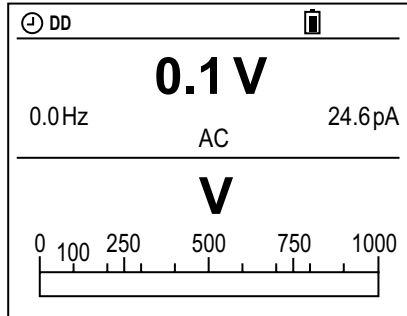
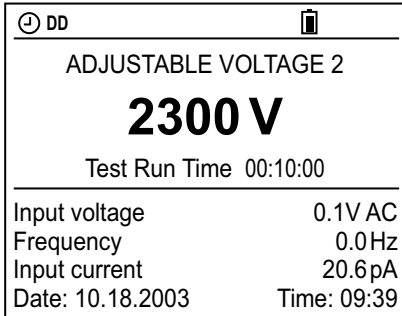

Information Displayed:
Test type and DC test voltage
Programmed duration of the test
AC/DC input voltage
Frequency
Residual current
Date, time

Information after pressing DISPLAY:
AC/DC input voltage
Frequency
Residual current
Voltage bargraph

DURING the measurement:

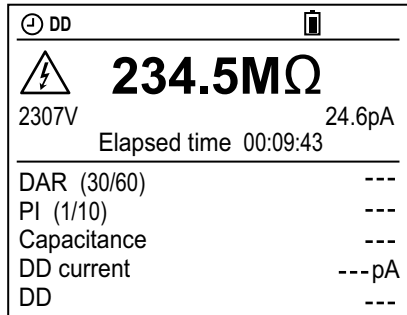
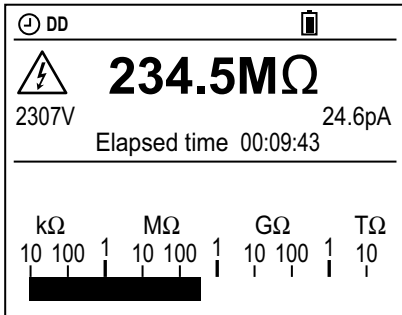

Information Displayed:
Measured resistance
DC test voltage
Leakage current
Remaining measurement time
Insulation resistance bargraph

Information after pressing DISPLAY:
Measured resistance
DC test voltage
Leakage current
Remaining measurement time
DAR, PI, Capacitance
Residual current (calculation of DD)
DD

AFTER the measurement:

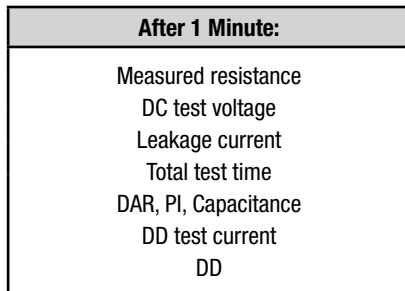
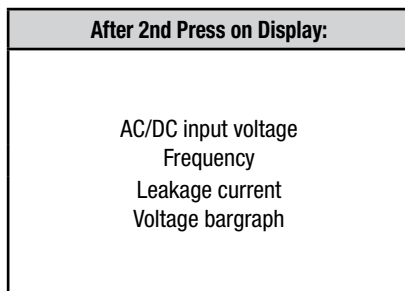
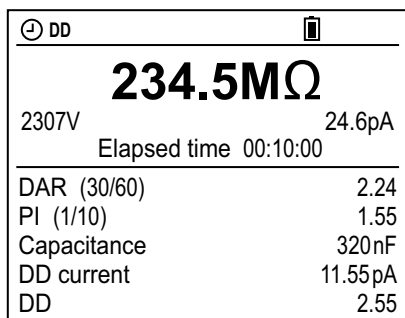
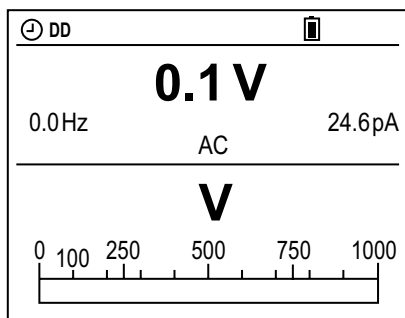
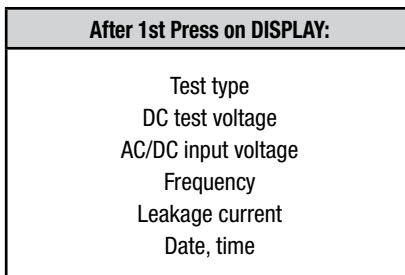
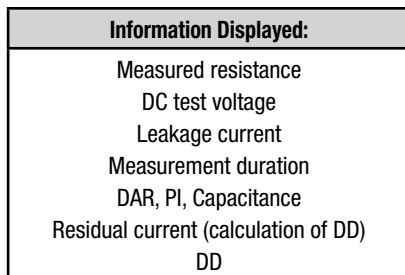
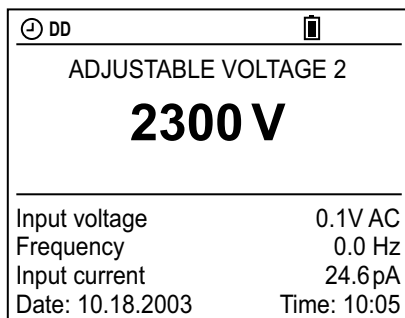
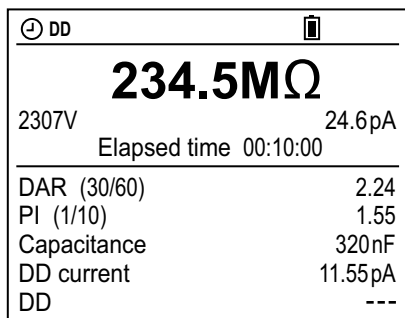

DAR mode

BEFORE the measurement:

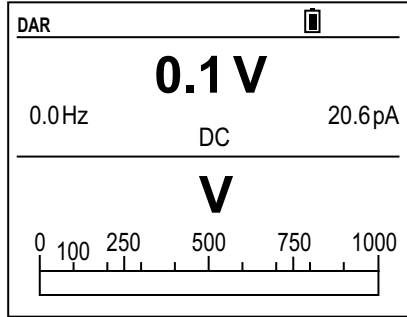
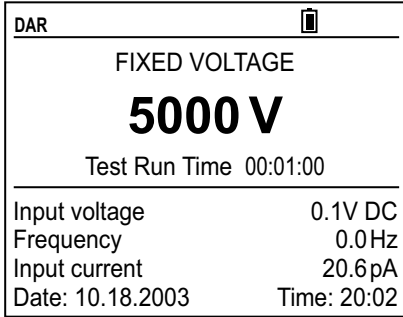

Information Displayed:

Test type
 DC test voltage
 Programmed duration of the test
 AC/DC input voltage
 Frequency
 Residual current
 Date and Time

Information after pressing DISPLAY:

AC/DC input voltage
 Frequency
 Residual current
 Voltage bargraph

DURING the measurement:

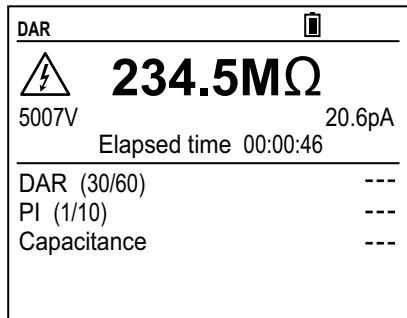
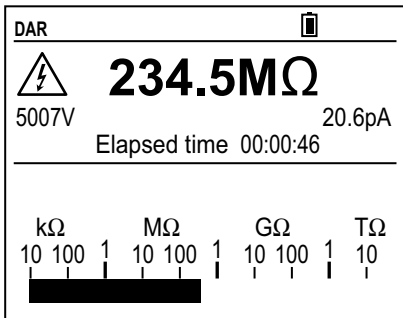

Information Displayed:

Measured resistance
 DC test voltage
 Leakage current
 Remaining measurement time
 Insulation bargraph

Information after pressing DISPLAY:

Measured resistance
 DC test voltage
 Leakage current
 Remaining measurement time
 DAR, PI, Capacitance in process

AFTER the measurement:

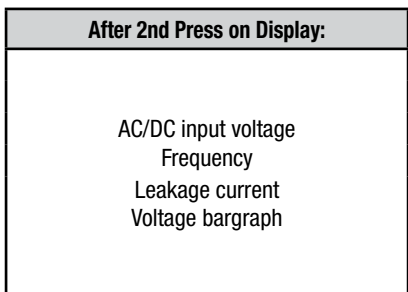
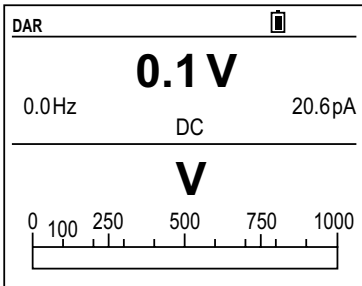
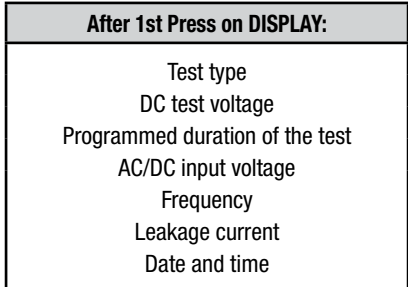
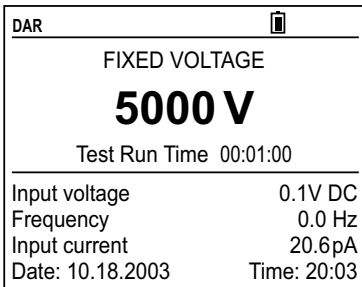
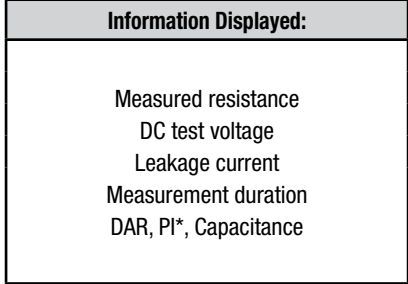
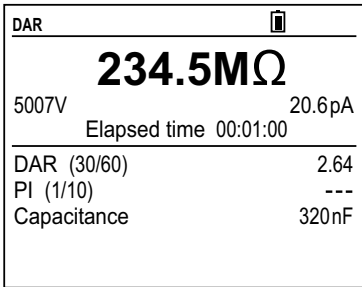

**NOTE: Because the test will stop after the DAR calculation, PI will not be calculated if the time values for this test are longer than those set for DAR.*

PI mode

BEFORE the measurement:

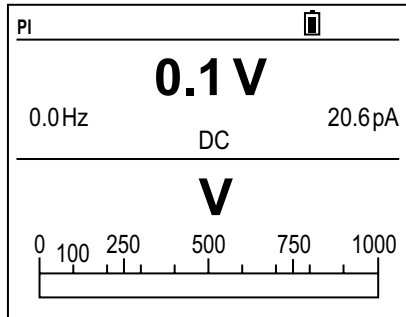
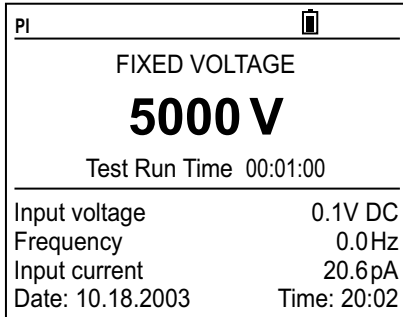

Information Displayed:

Test type
DC test voltage
Programmed duration of the test
AC/DC input voltage
Frequency
Residual current
Date and Time

Information after pressing DISPLAY:

AC/DC input voltage
Frequency
Residual current
Voltage bargraph

DURING the measurement:

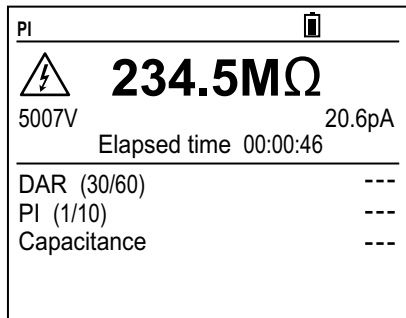
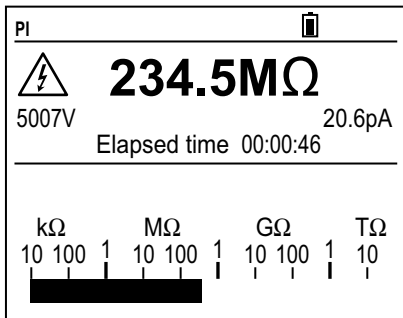

Information Displayed:

Measured resistance
DC test voltage
Leakage current
Remaining measurement time
Insulation bargraph

Information after pressing DISPLAY:

Measured resistance
DC test voltage
Leakage current
Remaining measurement time
DAR, PI, Capacitance in process

AFTER the measurement:

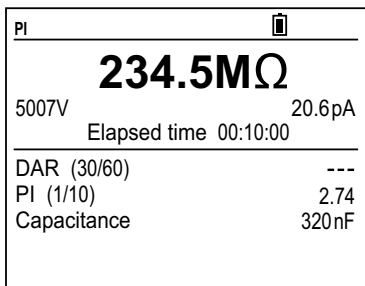

Information Displayed:
Measured resistance
DC test voltage
Leakage current
Measurement duration
DAR, PI*, Capacitance

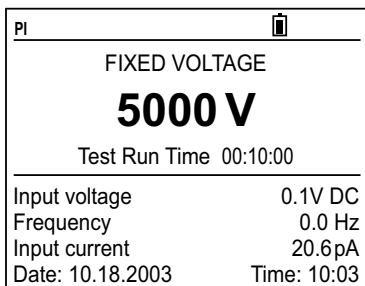

After 1st Press on DISPLAY:
Test type
DC test voltage
Programmed duration of the test
AC/DC input voltage
Frequency
Leakage current
Date and time

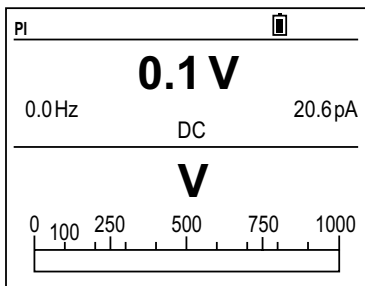

After 2nd Press on Display:
AC/DC input voltage
Frequency
Leakage current
Voltage bargraph

4.3.2 Secondary Function - GRAPH

At the end of a programmed Time Test (Timed Run or Timed Run + DD) pressing the **2nd + GRAPH** buttons will bring up a display of the Insulation Resistance versus time curve.

The resolution of this presentation is dependent on the sample time selected before the test or during set-up.

The ◀ and ▶ buttons can be used to move the vertical cursor along the time axis to display the Insulation Resistance and elapsed test time at the cursor position.

Pressing the **DISPLAY** button returns to the Digital Presentation of Results.

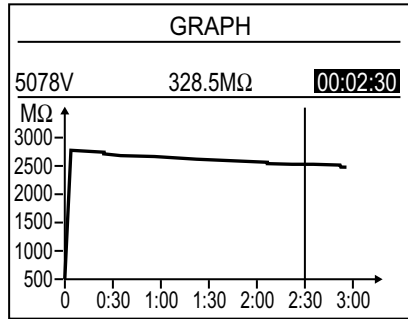

4.4 ◀ / TEMP Button

4.4.1 Primary Function - ◀

Selects the parameter to be modified to the left or moves the cursor on a graph screen to the left.

4.4.2 Secondary Function - TEMP

At the completion of a test, press the **2nd + TEMP** buttons. This brings up the Temperature Correction display.

This function provides the ability to display and store temperature corrected Insulation Resistance readings. Therefore, tests compared to historical data can all be referenced to a common temperature for better qualitative analysis.

NOTE:

- The TEMP function can be activated only after a measurement has been completed either before or after it is stored.
- If the result of your measurement is outside of the instrument's range (the display shows the < or > symbol next to the reading), the Temperature Correction function cannot be applied.
- Temperature correction is not available on Step Voltage tests.

Procedure:

- You have made a measurement and not yet stored it. Check that the result is within the Instrument's measurement range.
- Enter the TEMP mode by pressing the **2nd + TEMP** buttons.
- Enter the estimated temperature (Probe Temperature) at which you made the measurement (by default, the instrument offers the value set in SET-UP).
- With the blinking cursor next to "Probe Temperature", press the **▶** button to activate probe temperature. Use the **▲** or **▼** buttons to increase or decrease the temperature.
- Press the **◀** or **▶** buttons to move the cursor back to the selection position.
- Next, make sure "Resistance Correction" is turned "on" to perform the calculation (the default value in SET-UP is "off").
- Press the **▼** button to select "Resistance Correction". Press the **▶** button to highlight "off", then press the **▲** or **▼** buttons to select "on".
- The calculation is performed immediately and the result is displayed as R_c along with the Reference Temperature.
- This indicates what the measurement result would have been at the reference temperature.
- The Reference Temperature (R_c Reference Temperature) and the coefficient ΔT indicated and used for the calculation are those defined in SET-UP.

TEMPERATURE	
<input checked="" type="checkbox"/> Probe Temperature	23.7°C
Resistance Correction	on
R_c Reference Temperature	28.5°C
ΔT for $R/2$	23.0°C
<hr/>	
R measured	273.7M Ω
R_c at 28.5°C	328.5M Ω

TEMPERATURE	
Probe Temperature	23.7°C
<input checked="" type="checkbox"/> Resistance Correction	on
R_c Reference Temperature	28.5°C
ΔT for $R/2$	23.0°C
<hr/>	
R measured	273.7M Ω
R_c at 28.5°C	328.5M Ω

Note: To store this calculation, press the **2nd + TEMP** buttons again (OK is then displayed) before storing everything.

NOTE:

- During the procedure, pressing the **DISPLAY** button or turning the rotary switch cancels the calculation in progress.
- If the coefficient ΔT used for the calculation is not known, the instrument can calculate it in advance using at least 3 stored measurements made at different temperatures (see § 4.10).

The calculation is performed as follows:

The insulation resistance varies with the measurement temperature. This dependence can be approximated by the expression:

$$R_c = K T * R T$$

where:

R_c: Corrected Insulation Resistance to the reference temperature
Reference Temperature

RT: Measured Insulation Resistance at Probe Temperature

KT: Coefficient T defined as follows:

$$K T = (1/2) ((R_c \text{ Temperature Reference} - T) / \Delta T)$$

T: Probe Temperature

ΔT: Temperature change for which the Insulation Resistance is divided by 2

R_c Temperature Reference: Temperature to which the Insulation Resistance measurement is adjusted

Example: A motor winding is tested at 1000V in a 68°F environment. At the end of the timed test, the Insulation Resistance Value is 991 megohms. All the historical data is at 104°F. The corrected Insulation Resistance value corrected to 104°F for this motor is calculated by the Model 5070 to be 284.4 megohms using the formula above when temperature correction is activated.

4.5 ▼ / SMOOTH Button

4.5.1 Primary Function - ▼

Decreases the value of the flashing parameter displayed or selects the next parameter down.

4.5.2 Secondary Function - SMOOTH

The SMOOTH function (activated by pressing the **2nd + SMOOTH** buttons) activates/deactivates an insulation measurement digital filter.

Only the display is affected (which is smoothed), not the measurements. This function is useful if the insulation values displayed are very unstable.

The filter is calculated as follows:

$$R_{SMOOTH} = R_{SMOOTH} + (R - R_{SMOOTH}) / N$$

Since N is set to 20, the time constant of this filter is approximately 20 seconds. Therefore, displayed results are presented more smoothly.

4.6 ▲ / ALARM Button

4.6.1 Primary Function - ▲

Increases the value of the flashing parameter displayed or selects the next parameter up.

4.6.2 Secondary Function - ALARM

To activate the ALARM function before or during a test, press the **2nd + ALARM** buttons. The word **ALARM** will appear at the top right side of the display.

If the insulation resistance drops below the set value at any time during the test, the **ALARM** symbol will flash and the buzzer will be continuously on (if activated), as long as the alarm condition exists.

The alarm function can be deactivated at any time by pressing the **2nd + ALARM** buttons again.

4.7 ► / ☀ Button

4.7.1 Primary Function - ►

Selects the parameter to be modified to the right or moves the cursor on a graph screen to the right.

4.7.2 Secondary Function - ☀

To activate the display backlight, press the **2nd + ☀** buttons.

To deactivate, press the **2nd + ☀** buttons again.

4.8 MEM / MR Button

4.8.1 Primary Function - MEM (Save)

Results can be recorded in the instrument's memory and stored along with addresses defined by an object number (OBJ) and a test number (TEST).

An object represents a 'box' into which you can place 99 tests. An object can represent a single piece of equipment, such as a motor or pump or a department or an entire facility. Tests will represent the insulation resistance measurements carried out on the object.

Example: If the object is a 3-phase motor, then each test number will represent a specific insulation resistance measurement.

e.g. - Test 1 = Phase A to housing
Test 2 = Phase B to housing
Test 3 = Phase C to housing
and so on.

When the MEM button is pressed, the following screen is displayed:

- The flashing cursor identifies the first free Obj : Test location.

Here - **02 : 59** (the Obj. number is that of the last measurement stored, but the Test number is incremented by 1).

- It is always possible to modify Obj. Test using the ▲ , ▼ , ◀ , ▶ buttons.
- If a new Obj. is selected, the test number is set to 01 automatically.
- If you select a memory address that is already occupied, the screen to the right is displayed and prompts you to confirm or cancel deletion of the content of that address.
- To confirm overwriting, press the ► button.
- To cancel, press the ▼ button to highlight CANCEL, then press the ► button to confirm.

When the MEM key is pressed again, the measurement results are recorded at the selected memory address (whether occupied or not).

Store		MEMORY			
Obj.	Test	Date	Time	Fct.	
▶ 02	59	12.07.2003	22:39	3800V ⊖	
02	58	11.29.2003	15:47	50V ⊖	
02	03	11.24.2003	15:04	2150V	
02	02	10.29.2003	21:45	975V	
02	01	09.30.2003	02:43	5000V ⊖	
01	02	09.02.2003	15:07	↳ ⊖	

Store		MEMORY			
!WARNING!					
Old data set will be overwritten !					
▶ O.K.					
CANCEL					

All information from the measurement will be stored at a single location in memory: date, time, test mode and voltage, insulation resistance, capacitance, residual cur-

rent, and, possibly, DAR, PI, DD (if available), temperature corrected resistance and the R(t) graph.



WARNING: If a button other than MEM is pressed, or the selector switch is moved before pressing MEM a second time, the instrument exits from MEM mode without saving the results.

Memory Capacity

- Total memory space: 128kb
- Data management: 8kb
- Free memory space: 120kb

An insulation measurement requires 80 bytes. Therefore, approximately 1500 insulation measurements can be stored.

Free Memory Space

This function is automatically activated when a result is saved.

Press the **MEM** button once to bring up the first available Object and Test storage location. A bargraph is displayed corresponding to the available memory location.

- If the entire memory is free, all of the bargraph segments appear.
- If the entire memory is full, the arrow to the left of the bargraph flashes.
- As soon as the storage is complete, the bargraph disappears.

Each segment of the bargraph equals approximately 50 recordings.

4.8.2 Second Function - MR (Recall)

The **MR** function allows you to recall any of the stored data from memory, regardless of the position of the rotary selector switch, except OFF or SETUP.

When the MR button is activated, the following screen is displayed:

- The flashing cursor identifies the last occupied Obj. and Test number.
Here - **47 : 99**

- Use the **▲**, **▼**, **◀**, **▶** buttons to select the desired Obj. and Test number.
- After selecting the Obj. and Test, press the **▶** button to access the first item of information relative to this measurement.
- To access more data, press **DISPLAY** repeatedly, or **GRAPH**, if the mode selected before the start of the measurement allows.

Recall	MEMORY			
	Obj. Test	Date	Time	Fct.
▶	47 99	12.15.2003	07:04	625V
	13 59	12.07.2003	22:39	3800V ⊕
	13 58	11.29.2003	15:47	50V ⊕
	02 03	11.24.2003	15:04	2150V
	02 02	10.29.2003	21:45	975V
	02 01	09.30.2003	02:43	5000V ⊕
	01 02	09.02.2003	15:07	⏏ ⊕

To exit the MR function, press the **MR** button once again or turn the selector switch to another position.

4.9 Clearing the Memory

In SET-UP, select “Clear memory” by using the ▼ button to highlight this function. Press the ► button to enter this mode.

To erase the content of one or more specific OBJ : TEST numbers:

- Select “Select Data Sets to Clear” by pressing the ► button.
- Then, select each memory to be erased using the ▲ , ▼ buttons to choose it and the ► button to select it. The ◀ button will deselect it.
- Validate by pressing **DISPLAY**. The operation is confirmed by pressing the ► button with the OK option highlighted, or cancelled by pressing the ► button with the CANCEL option highlighted.

SET-UP	
Instr.Nr. 9600004	SW Version 1.2
Rc reference temperature	40°C
ΔT for R/2	10°C
Calculate ΔT from Memory	
Maxumum Output Voltage	5100V
Set Default Parameter	
<input checked="" type="checkbox"/> Clear Memory	
V Disturbance / V Output	30%
Buzzer	on

SET-UP
Clear memory:
<input checked="" type="checkbox"/> Select Data Sets to Clear
Clear All

SET-UP				
Clear memory:				
Obj.	Test	Date	Time	Fct.
47	99	15.12.2003	07:04	625V
<input checked="" type="checkbox"/>	<input checked="" type="checkbox"/>	13 59	07.12.2003	22:39 3800V ⊖
<input checked="" type="checkbox"/>	<input checked="" type="checkbox"/>	13 58	29.11.2003	15:47 50V ⊖
02	03	24.11.2003	15:04	2150V

SET-UP
!WARNING!
All selected data sets will be cleared!
<input checked="" type="checkbox"/> O.K.
CANCEL

To erase the *entire* memory:

- Select “Clear All” by pressing the ▼ button to highlight it and the ► button to choose it.
- The operation is confirmed or cancelled by pressing the ► button when the appropriate choice is highlighted as described above.

SET-UP
Clear memory:
Select Data Sets to Clear
<input checked="" type="checkbox"/> Clear All

SET-UP
!WARNING!
All data sets will be cleared!
<input checked="" type="checkbox"/> O.K.
CANCEL

4.10 Calculation of ΔT from Stored Data

The coefficient ΔT is used to calculate the insulation resistance at a temperature other than the measurement temperature. It is the temperature difference at which the insulation resistance concerned is divided by 2.

This coefficient is variable and depends on the type of insulation. When it is not known, the instrument can calculate it from three or more stored measurements.



NOTE: These 3 measurements must have been made on identical insulation but at 3 different temperatures, and the temperatures must have been recorded using the 2nd + TEMP buttons at the same time as the measurements, without applying the correction (Resistance Correction OFF).

- In the SET-UP mode, select “Calculate ΔT from Memory” and press the ► button. The display shows all values recorded with a temperature.
- Select at least 3 measurements using the ▲ , ▼ , ◀ , ▶ buttons.
- ΔT is calculated and recorded automatically once 3 stored measurements have been selected, and will be updated if more measurements are selected.
- The larger the number of measurements, the more accurate the calculation of ΔT .



NOTE: This calculation is available only for resistance values < 200G Ω .

SET-UP	
Instr.Nr. 9600004	SW Version 1.2
► Calculate ΔT from Memory	
Maxumum Output Voltage	5100V
Set Default Parameter	
Clear Memory	
V Disturbance / V Output	10%
Buzzer	on
Power Down	on
Baud Rate	9600 / RS232

SET-UP				
ΔT Calculation for R/2			23.7°C	
Obj.	Test	Res.	Volt.	Temp.
47	99	228.5M Ω	5078V	23°C
13	59	208.5M Ω	5078V	30°C
13	58	178.5M Ω	5078V	37°C
► 02	03	328.5M Ω	5078V	23°C
02	02	328.5M Ω	5078V	23°C
02	01	328.5M Ω	5078V	23°C

4.11 Maximum Output Voltage

In the SET-UP menu, select “Maximum Output Voltage” pressing the ▼ button to highlight it and the ► button to choose it.

Adjust the maximum output voltage using the ▲ , ▼ buttons.

This function prohibits the use of test voltages higher than the selected maximum output voltage for the insulation measurement.

The instrument can then be used by less experienced personnel for specific applications where it is important not to exceed a maximum test voltage.

SET-UP	
Instr.Nr. 9600004	SW Version 1.2
Calculate ΔT from Memory	
► Maximum Output Voltage	5100V
Set Default Parameter	
Clear Memory	
V Disturbance / V Output	10%
Buzzer	on
Power Down	on
Baud Rate	9600 / RS232

Example: if the maximum output voltage is set to 750V and the measurement is made in the 5000V switch position, only 750V will be generated.

4.12 List of Error Codes

If an inconsistency is detected when the instrument is started up or in operation, the display unit indicates an error code. The format of this error code is a 1 or 2 digit number. This number identifies the problem and the action to be taken.

Here are some examples of possible errors:



NOTE: Codes from 0 to 9 identify fatal errors in the hardware. The instrument must be returned to AEMC® Instruments for corrective action.

Codes from 20 to 25 identify semi-fatal errors, except for codes 21 and 25. The instrument must be returned to AEMC® Instruments for corrective action.

- Error 20** Communication failed
- Error 21** Check of options failed
- Error 22** Check of contents failed
- Error 23** Check of calibration values failed
- Error 24** Check of instrument identification number failed
- Error 25** Check of print file failed

For non-fatal errors 21 and 25, it is not necessary to return the instrument. Simply use the SET-UP mode to restore the default parameters (Set Default Parameter).

Data Storage Error:

If it becomes impossible to store data, the entire content of memory must be erased using the “Clear Memory” function in the SET-UP mode (see §4.9).

MEASUREMENT FUNCTIONS

5.1 AC/DC Voltage

- Turn the rotary selector switch to any insulation position (other than OFF or SET-UP).
- The instrument is now automatically in AC/DC voltage measurement mode.
- The voltage between the input terminals is measured at all times and indicated on the display next to the input voltage heading.
- Also, as soon as the switch is turned, the frequency and the residual DC current at the terminals of the instrument are measured. The residual current is measured in order to evaluate its effect on the insulation measurement about to be performed.



NOTE: Measurement is prohibited if an external voltage above a preset value is present at the terminals before pressing START/STOP to start a test.

Similarly, if an interference voltage of a preset value is detected during measurement, the measurement is stopped and that voltage is indicated (see V Disturbance / V Output on page 25).

5.2 Insulation Measurement

When the switch is turned to an insulation resistance measurement position, one of following appears:

Case 1

You select an insulation measurement with a fixed/standard test voltage, in manual mode.



Switch Positions:

500V - 2T Ω

1000V - 4T Ω

2500V - 10T Ω

5000V - 10T Ω

	
FIXED VOLTAGE	
2500 V	
Input voltage	 230V AC
Frequency	50.0 Hz
Input current	24.6nA
Date: 09.28.2003	Time: 22:39

Case 2

You select an insulation measurement with one of the selectable test voltages.

Switch Position: **50 to 5000V**

You can choose from one of the three selected voltages predefined in SET-UP using the ▲ and ▼ buttons, selecting adjustable voltage 1, 2 or 3, or define another voltage by selecting it with the ► button to highlight the test voltage and adjusting it with the ▲ and ▼ buttons. The new selected voltage will not be saved when the instrument is shut off or the rotary switch is moved to another position.

ADJUSTABLE VOLTAGE 2	
2300 V	
Input voltage	20V AC
Frequency	50.0 Hz
Input current	24.6nA
Date: 09.28.2003	Time: 22:39

Case 3

You select an insulation measurement with a test voltage that varies in steps (this is the “Step Function” mode).

Switch Position :

Step Voltage

You can choose from the three stored step voltage schemes using the ▲ and ▼ buttons.

STEP FUNCTION 1		
Min: 2300V		Max: 3900V
Test Run Time 08:38:30		
Input voltage	1V AC	
Frequency	50.0 Hz	
Input current	24.6nA	
Date: 09.28.2003	Time: 22:39	

- **Pressing the START/STOP button immediately begins the measurement process.**

If the beeper is selected as “ON” in the SET-UP mode, an audible beep is emitted every 10 seconds to indicate that a test is in process.

A number of special functions can be performed during the test. Chapter 4 describes these functions.



WARNING: Insulation measurements cannot be started if there is an excessively high external voltage on the “+” and “-” terminals.

The Model 5070 will automatically inhibit testing.

- **When the START button is pressed**, if the external voltage of the terminals of the Model 5070 is greater than the value V_{peak} defined in the set-up mode and described next, the insulation test is not started and an audible alarm is emitted; the instrument then returns to automatic voltage measurement mode.

$$V_{\text{peak}} \geq dISt \times V_N$$

where - V_{peak} is the external voltage, (peak or DC) at the + and – terminals of the Model 5070.

- $dISt$ is the coefficient that can be selected in SET-UP at 3% (default value), 10 or 20%.

- V_N is the test voltage selected for the insulation measurement.

Example A: The test is to be conducted at 2500V, $dISt$ is set to 3%. Therefore, before the test starts, a voltage present at the “+” and “-” terminals of 75V will cause the Model 5070 to inhibit testing. ($V_{\text{peak}} = (0.03 \times 2500V) = 75V$)

Similarly, if during the insulation test, an external voltage greater than the V_{peak} (as defined below) is detected, the measurement is stopped and the symbol  appears next to the value of the external voltage measured.

$$V_{\text{peak}} \geq (dISt + 1.05) \times V_N,$$

where - V_{peak} is the external voltage, (peak or DC) at the + and – terminals of the Model 5070.

- $dISt$ is the coefficient that can be selected in SET-UP at 3% (default value), 10 or 20%.

- V_N is the test voltage selected for the insulation measurement.

Example B: If the conditions defined in Example A were programmed and the test was started, a disturbance voltage (change of voltage) of 2700V would abort the test. ($V_{\text{peak}} = (0.03 + 1.05) (2500V) = 2700V$)

Note: The $dISt$ factor is selected to optimize the measurement build-up time.

If there is no leakage voltage, $dISt$ can be adjusted to its minimum value to obtain the shortest possible measurement build-up time.

If there is a large leakage voltage, $dISt$ can be increased so that the measurement will not be interrupted as soon as a negative alternation occurs during the generation of the test voltage; this helps optimize the measurement build-up time in the presence of a leakage voltage.

- **Pressing the START/STOP button again stops the measurement**

If the “programmed time test” mode (Timed Run or Timed Run +DD) was selected as the test mode, the measurement is stopped (without pressing the **START/STOP** button) at the end of the test time.

Similarly, if the DAR or PI mode is selected as measurement mode before the test, the measurement is stopped automatically after the time programmed to calculate them has occurred (time defined in SET-UP).

A number of special functions can be used during the measurement (see § 4).

5.3 Capacitance Measurement

The capacitance measurement is performed automatically during the insulation measurement, and is displayed after the measurement stops and the circuit has been discharged.

5.4 Residual Current Measurement

The residual current circulating in the installation is measured and displayed automatically upon connection to the installation, it is all measured during and after the insulation measurement.

OPERATION



NOTE: Charge the instrument fully before use.





6.1 Performing Measurements

To begin an insulation resistance test, first insert the cables as necessary, then turn the rotary switch to the appropriate test voltage position.

The instrument can measure insulation values from 10k Ω to 10T Ω , depending on the test voltage selected—from 40V to 5100VDC.

The screen displays:

- The battery symbol and battery charge condition
- The test voltage selected
- The voltage, frequency and residual current at the input terminals
- The date and time

	
FIXED VOLTAGE	
2500 V	
Input voltage	 230V AC
Frequency	50.0 Hz
Input current	24.6nA
Date: 09.28.2003	Time: 22:39

Connect the Red (+) and the Black (-) cables to the test object. Connect the Blue Guard jumper and cable, if required for the test (see Appendix A “*When to use the Guard Terminal*”).

Next, (unless the step function mode is selected) select the measurement mode to be used (Manual Stop, Manual Stop +DD, Timed Run, Timed Run +DD, DAR or PI) by pressing the **MODE** button (see § 4.2.1)

- Press the **START/STOP** button to begin the measurement test.



NOTE: If the voltage present is greater than the maximum allowed value, the measurement will be prohibited.

The **DISPLAY** button can be used to scroll through the information available during the test.

This information depends on the measurement mode selected (see § 4.2.1).

If the insulation values displayed are very unstable, a digital filter can be activated by pressing **SMOOTH** to smooth them (see § 4.5.2).

The alarm mode can be activated by pressing the **ALARM** button. An audible beep will continuously sound if the measurement result is below the value defined in SET-UP (see page 20).

Press the **START/STOP** button again to stop the test.

The last result remains displayed until the next measurement is made or the switch is turned.

When the insulation measurement has stopped, the device under test will be automatically discharged by the Model 5070.

The **DISPLAY** button can be used to view the test results available after the test.

This information depends on the measurement mode selected (see § 4.2.1).

If the measurement mode was either “Timed Run” or “Timed Run + DD”, pressing the **GRAPH** button displays the insulation measurement versus time curve (see § 4.3.2).

Press the **TEMP** button to correct the measurement result to the reference temperature defined in SET-UP (see § 4.4.2).

6.2 Step Function Mode

This function is based upon the principle that ideal insulation produces the same resistance no matter what the test voltage applied.

Any negative variation of this resistance means that the insulation may be defective. The resistance of defective insulation will decrease as the test voltage increases.

This phenomenon is rarely observed with “low” test voltages, therefore at least 2500V must be applied.

The usual test condition is a voltage increasing in 5 steps, each lasting for 1 minute minimum.

Assessment of the result:

- A deviation of the resistance = f(test voltage) curve that exceeds 500ppm/V generally indicates the presence of mold or other deterioration.
- A larger deviation or a sudden drop indicates the presence of localized physical damage such as arcing or perforation of the insulation, etc.

Procedure:

- In the SET-UP menu, select “Set Step Function 1, 2 or 3” by scrolling down to set Step Function 1, 2 or 3 using the ▼ button. Press the ► button to enter the Set-up mode for the profile selected. The screen on the right shows the default profile for Step Function Number 3.
- Define the Step Function and the desired number of measurement samples (R(t) sample) by scrolling to the desired Step using the ▲ or ▼ buttons followed by the ► button to access the selected steps, voltage and time variables. Adjust the voltage for the Step by pressing the ▲ or ▼ buttons. Then, press the ► button to move the selection cursor to the duration setting. Adjust the hours and minutes for the step in the same fashion used to select the voltage. When finished, press the ► button until the cursor is again in the Step Column. Repeat this process for each of the five steps.

SET-UP		
Ramp 3 definition:		
Step	Voltage	Duration (h:m)
▣ 1	1000V	01:00
2	2000V	01:00
3	3000V	01:00
4	4000V	01:00
5	5000V	01:00
Total duration (h:m)		05:00
R(t) sample (m:s)		00:20

 **NOTE:** If a Step is not used, select “---” as the duration. Next, adjust the sample rate by the same procedure using the ▲▼ and ◀▶ buttons to select and adjust the sample rate.

- Once the Step Function is defined, turn the selector switch to Step Voltage (the desired profile 1, 2 or 3) using the ▲▼ buttons.
- Then, start the measurement by pressing the **START/STOP** button.

During the measurement, the following screens can be accessed by pressing the **DISPLAY** button:

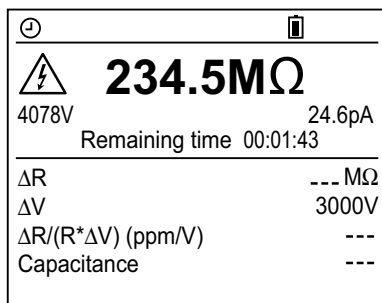
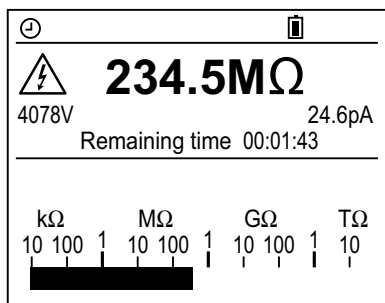

At the end of the measurement, the following are indicated:

- The difference ΔR in insulation resistance between the final resistance (with the highest test voltage) and the initial resistance (with the lowest test voltage)
- The difference ΔV between the final and initial test voltages
- The slope of the curve in ppm/V
- The capacitance

Pressing the **GRAPH** button displays the resistance versus applied test voltage curve.

Using the ◀ and ▶ buttons, you can scroll through the various samples recorded and for each see:

- The insulation resistance value
- The applied test voltage
- The time of measurement

234.5MΩ	
5078V	24.6pA
Elapsed time 00:05:00	
ΔR	8.5MΩ
ΔV	4000V
$\Delta R/(R*\Delta V)$ (ppm/V)	0.28
Capacitance	320nF

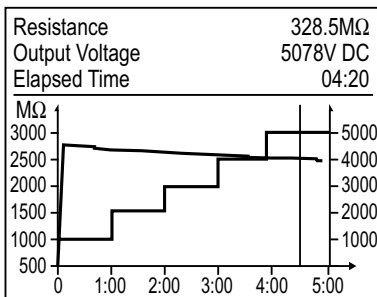

6.3 Operation Examples

Connection diagram for measurement of low resistance insulation (e.g. motor)

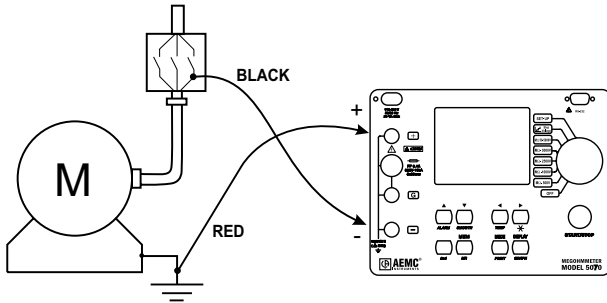

When measuring high levels of insulation ($> 1G\Omega$), it is advisable to use the “G” guard terminal to eliminate the influence of surface leakage currents. The guard is connected between the two measurement contact points, and the surface susceptible to surface currents, (e.g. dusty, damp cable or transformer insulation). In this case, alligator clips are preferable to hand-held test probes.

As soon as the insulation measurement is stopped, the test circuit is automatically discharged using the instrument’s internal discharge feature.

Connection diagram for measurement of high resistance insulation

a) Example of a motor (reduction of capacitive effects)

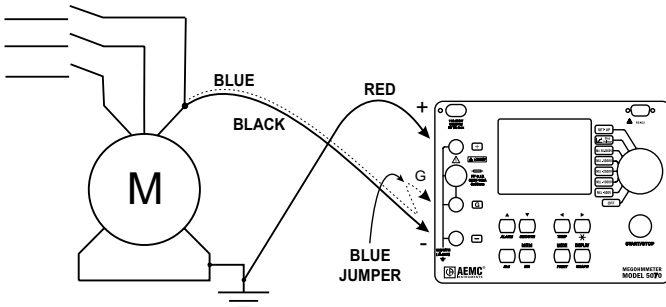

b) Example of a cable (reduction of superficial leak effects)

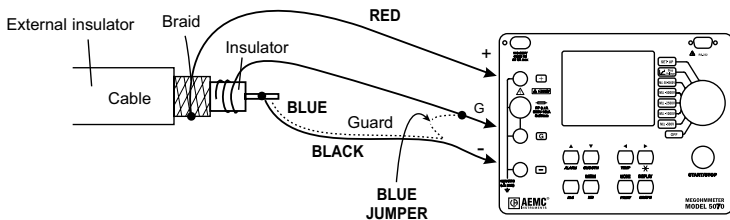

6.4 Printing Measured Values (MODE / PRINT Button)

To use a serial printer, first choose the appropriate communication baud rate in the **SET-UP** menu, between 300...9600 baud. Then program the printer to the 5070 format.

There are two print modes:

- Instantaneous printing of measurement (PRINT)
- Printing of recorded data (PRINT memory)

Pressing the PRINT button gives access to the following menu:

- **Print result:** Immediate printing of a measurement following that measurement or after accessing values in the MR mode.
- **Print memory:** Printing of stored data.
- **Baud rate / Port:** Baud rate adjusted in the SET-UP menu. The choices are 300, 600, 1200, 2400, 4800, 9600 or parallel.

After selection of the print mode :

- **If the transmission of data to the printer is successful**, the COM symbol flashes at the top left of the display unit.
- **If a problem occurs**, the COM symbol remains lit steadily at the top left of the display unit.

6.5 Instantaneous Printing of Measurements (Print Result)

When this print mode is selected, **the following are printed**, in order:

- General information concerning the measurement
- The measurement result
- If the TEMP function was activated, the measurement result referred to the reference temperature
- For a Timed Run test, the list of recorded samples

To stop printing, move the position of the selector switch to any other position.

Capacitance 110 nF

Elapsed time	Utest	Resistance
00:00:10	1020 V	2.627 GOhm
00:00:30	1020 V	2.627 GOhm
00:00:50	1020 V	2.627 Gohm
...etc.....		

Date of next test:/..../.....
Remarks:.....
.....
Operator:..
Signature:

6.6 Printing Data in Memory (Print Memory)

When this printing mode is selected, the content of the memory is displayed.

Stored measurements to be printed are selected using the ▲ , ▼ , ◀ , ▶ buttons.

Here, the measurements selected for printing are:

13 : 59
13 : 58
02 : 03
02 : 02

PRINT				
Obj. Test	Date	Time	Fct.	
47 99	12.15.2003	07:04	625V	
13 59	12.07.2003	22:39	3800V	⊖
13 58	11.29.2003	15:47	50V	⊖
02 03	11.24.2003	15:04	2150V	
▶ 02 02	10.29.2003	21:45	975V	
02 01	09.30.2003	02:43	5000V	⊖
01 02	09.02.2003	15:07		⊖

Once they have been selected, do one of the following:

- **To start printing**, press the **PRINT** key again.
- **To exit without printing**, change the rotary switch position.
- **To stop printing**, change the rotary switch position.

The printing of each group of data is reduced to the main results.

Temperature: 23°C
Relative humidity: %
Test voltage: 1000 V
Insulation resistance: 385 GOhm

Rc - calculated resist. 118.5 GOhm
at reference temperature 40°C
with ΔT for R/2 10°C

DAR (1'/30") 1.234
PI (10'/1') 2.345
DD --.--
Capacitance 110 nF
...etc.....

Date of next test: ../../.....
Remarks:.....
.....
Operator:..
Signature:

Step function measurement

AEMC Instruments Model 5070
Instrument number: 000 001
Company:.....
Address:.....
.....
Tel.:.....
Fax:.....
Email:.....
Description:.....

OBJECT: 01 TEST: 01

STEP FUNCTION TEST

Date 01.31.2003

Starting time: 14h55

Running time: 00:00:50

Temperature: 23°C

Relative humidity: %

		Step Duration	Voltage	Resistance
N°	h:mm	def.	actual	

1	0:10	1000 V	1020 V	2.627 GOhm
2	0:10	2000 V	2043 V	2.411 GOhm
3	0:10	3000 V	3060 V	2.347 GOhm
4	0:10	4000 V	3755 V	2.182 GOhm
5	0:10	5000 V	3237 V	2.023 GOhm

1 0:10 1000 V 1020 V 2.627 GOhm

2 0:10 2000 V 2043 V 2.411 GOhm

3 0:10 3000 V 3060 V 2.347 GOhm

4 0:10 4000 V 3755 V 2.182 GOhm

5 0:10 5000 V 3237 V 2.023 GOhm

ΔR 604 GOhm

ΔV 4000 V

$\Delta R / (R * \Delta V)$ (ppm/V) -57 ppm

Capacitance 110 nF

OBJECT: 01 TEST: 03

...etc.....

Date of next test: ../../.....

Remarks:.....

.....

Operator:

Signature:

DATAVIEW® SOFTWARE

7.1 Introduction

The DataView® software, supplied with the Model 5070 megohmmeter, provides four main functions:

1. The ability to configure the 5070 megohmmeter from the computer.
2. The ability to initiate a timed test from the computer.
3. The ability to store test results and print out reports of any test.
4. The ability to see a plot of the test in real-time on the computer screen.

7.2 Features

DataView® has a simple, easy-to-use interface for configuring and running tests with the Model 5070, as well as, plotting and printing reports of the test results. There are many features that are available through DataView®.

Key Features:

- Configure all functions of the Model 5070
- Select test voltage and run tests from your computer with a simple click and execute process
- Capture and display data in real time
- Retrieve data from the instrument's memory
- Display DAR, PI and DD ratios, Resistance, Capacitance, Leakage Current Values and Temperature Corrected Resistance
- Plot graphs of manual and timed tests
- Include your analysis in the comments section of the report
- Store a library of setups for different applications
- Provide consistency in testing, regardless of who performs the test



NOTE: For additional help on using the software, use DataView's "Help" Menu, which is located on the menu bar.

7.3 Installing DataView®



INSTALL THE DATAVIEW® SOFTWARE BEFORE INSTALLING THE USB DRIVERS AND BEFORE CONNECTING THE INSTRUMENT TO THE COMPUTER.

Minimum Computer Requirements:

- Windows® 2000/XP/Vista
- 128MB of RAM for Windows® 2000 (256MB recommended)
256MB of RAM for Windows® XP
512MB of RAM for Windows® Vista
- 80MB of hard disk space (200MB recommended)
- CD-ROM drive

NOTE: When installing DataView® on a Windows® 2000, XP or Vista system the user must have Administrative access rights during the installation.

The users access rights can be changed after the installation is complete. The user does not need administrative access rights when using DataView®.

DataView® must be reinstalled for each user in a multi-user system (e.g. Windows® 2000, XP and Vista).

1. Insert the DataView® CD into your CD-ROM drive.

If auto-run is enabled, the Setup program will start automatically. If auto-run is not enabled, select Run from the Start menu and type in **D:\SETUP** (if your CD-ROM drive is drive D. If this is not the case, substitute the appropriate drive letter).



NOTE: If installing onto a Vista based computer the **User Account Control** dialog box will be displayed. Select the **Allow** option to proceed.

2. A **Set-up** window, similar to Figure 7-1, will appear.

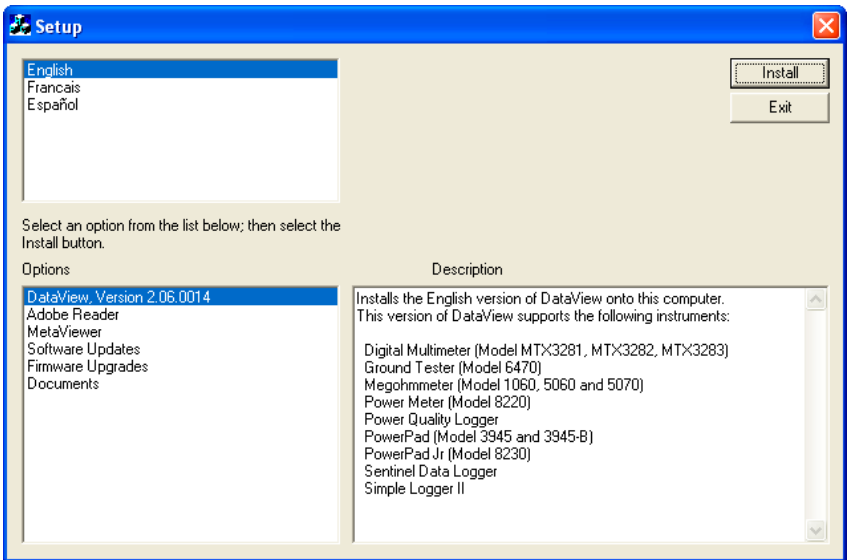

Figure 7-1

There are several different options to choose from. Some options(*) require an internet connection.

- **DataView, Version 2.xx.xxxx** - Installs DataView® onto the PC.
 - ***Adobe Reader** - Links to the Adobe® website to download the most recent version of Adobe® Reader to the computer. *Adobe® Reader is required for viewing PDF documents supplied with DataView® that are accessible from the Help menu.*
 - **MetaViewer** - The MetaViewer utility program allows a user to view and print .dmf or .emf files generated by DataView® without having DataView® software installed.
 - ***Software Updates** - Links to the AEMC® Software Update website to check for new software version releases.
 - ***Firmware Upgrades** - Links to the AEMC® Firmware Upgrade website to check for new firmware version releases.
 - **Documents** - Shows a list of instrument related documents that you can view. Adobe® Reader is required for viewing PDF documents supplied with DataView®.
3. Select the **DataView, Version 2.xx.xxxx** option from the list, then click on **Install**.
 4. The **Installation Wizard** window will appear. Click **Next**.

5. In the **Customer Information** window, enter a Name and Company, then click **Next**.
6. In the **Setup Type** window that appears, select the “**Complete**” radio button option, then click **Next**.
7. The **Select Features** window appears allowing features for all instruments compatible with DataView® to be selected or not selected to install. Select the instrument(s) that you want to install. You can update the software to include other instruments later, if necessary.



NOTE: The **PDF-XChange** option must be selected to be able to generate PDF reports from within DataView®.

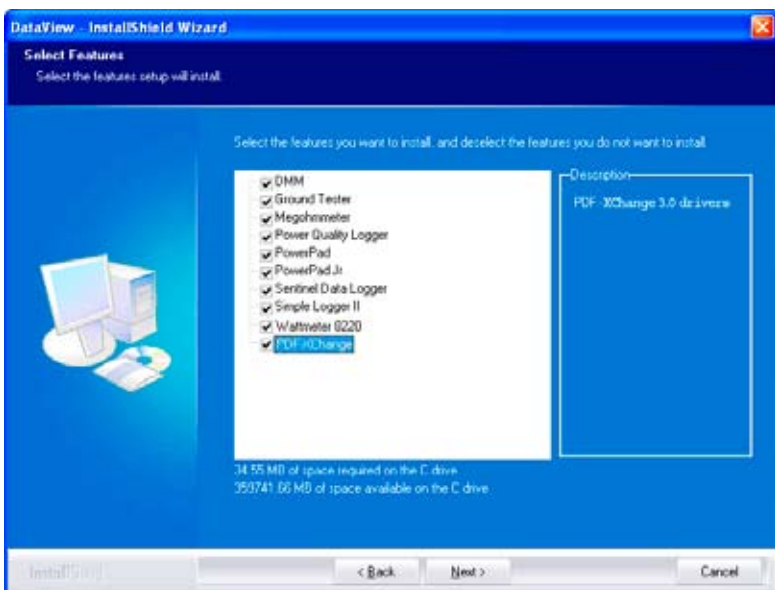

Figure 7-2

8. In the **Ready to Install the Program** window, click on **Install**.
9. If the instrument selected for installation (see Figure 7-2) requires the use of a USB port, a warning box will appear, similar to Figure 7-3. Click **OK**.

If the USB drivers are not needed, Setup will continue at step 12.

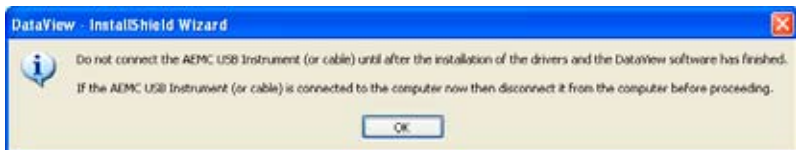

Figure 7-3

10. The **Install Driver** dialog box will appear. Click on **Install**.



Figure 7-4



NOTE: The installation of the drivers may take a few moments. Windows may even indicate that it is not responding, however it is running. Please wait for it to finish.

11. When the drivers are finished installing, the **Installation Successful** dialog box will appear. Click on **OK**.
12. Next, the **Installation Wizard Complete** window will appear. Click on **Finish**.
13. A **Question** dialog box appears next. Click **Yes** to read the procedure for connecting the instrument to the USB port on the computer.
14. Restart your computer before connecting the instrument to the USB port on the computer.



NOTE: The Set-up window should still be open. You may now select another option to download (e.g. Adobe® Reader), or you may close the window.

Shortcuts for DataView® and each instrument selected during the installation process have been added to your desktop.

7.4 Installing the USB Drivers for Each Instrument



INSTALL DATAVIEW® SOFTWARE AS SHOWN IN THE PREVIOUS SECTION BEFORE CONNECTING THE INSTRUMENT TO THE COMPUTER.

The USB driver operates at two levels.

- **First Level:** This level is for communication between the instrument and the USB port. ***This is done automatically during DataView's installation.***
- **Second Level:** This level is for communication between the DataView application and the USB port. ***This is done when the instrument is connected to the computer.***

Upon the Second Level installation, the **Found New Hardware** dialog box will be displayed. Windows will complete the driver installation process automatically.



NOTE: If you connected your instrument to the computer before installing the software and drivers, you may need to use the **Add/Remove Hardware** utility to remove the instrument driver before repeating the process.

7.5 Connecting the Model 5070 to your Computer

The Model 5070 is supplied with a serial interface cable necessary for connecting the instrument to the computer. This cable (Cat. #2119.45) is equipped with a 9-pin connector on each end (see diagram in Appendix B).

To connect the megohmmeter to your computer:

- Connect the 9-pin connector from one end of the cable to the serial port on the front panel of the Model 5070 megohmmeter.
- Connect the 9-pin connector from the other end of the cable to an available serial port on the back of your computer.

You are now ready to communicate using the DataView® Program with the megohmmeter.

7.6 Using DataView®

Once the serial connection between the computer and the Model 5070 has been completed, as described above, start the DataView® program.

There are two ways to open and use the DataView® software:

Using the Megohmmeter Icon

- Double-click the **Megohmmeter Icon** that was created during installation, located on the desktop.
- DataView® will open and the **Connection** window will appear (see Figure 7-6).

Using the DataView Icon

- Double-click the **DataView Icon** that was created during installation, located on the desktop.
- DataView® will open and display the **DataView Quick Start** window (see Figure 7-5).
- Click the **Configure Instrument** button and the **Connection** window will appear (see Figure 7-6).

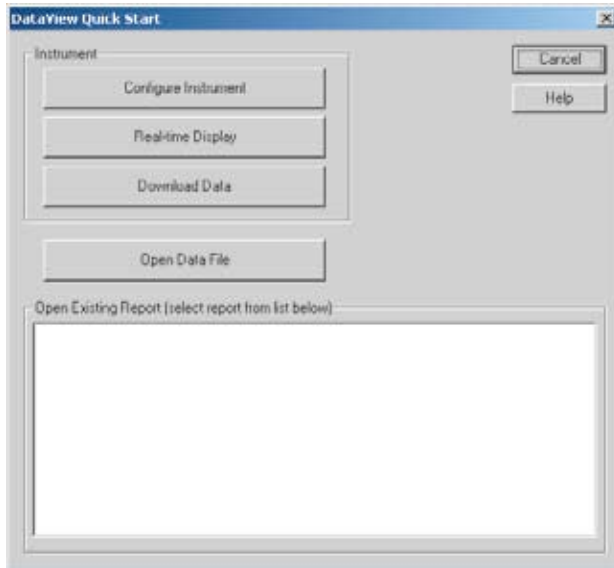

Figure 7-5

7.6.1 Configuring the Instrument

To configure the instrument, perform the following steps.

1. Click the **Configure Instrument** button. A dialog box will open, allowing you to select the Baud Rate and the Serial Port for communicating with the Model 5070.

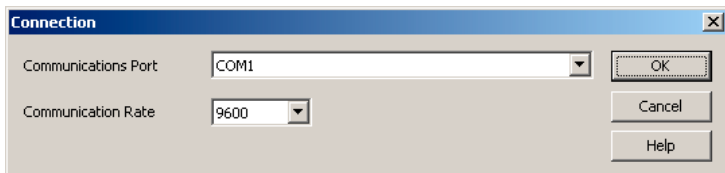

Figure 7-6

2. Make sure that the serial port displayed in the dialog box matches the port you plugged the serial cable into. If the correct serial port is not selected, click on the drop down arrow and select the proper one. Com 1, 2, 3 and 4 are supported.
3. The Baud Rate will default to 9600 and should be acceptable to any computer. This is also the default rate for the Model 5070. You may select a different rate by clicking on the drop down arrow in the Baud Rate window and selecting from the available rates. DataView® will automatically try each rate, should the selected baud rate that was initially selected not match that which is programmed into the Model 5070.

- Once the proper communication parameters have been specified click on the OK button.



NOTE: The instrument must be configured for the same communications rate specified in Figure 7-6. If it is not, then you must either select the corresponding rate or change the instruments rate. (see page 26 for selecting the baud rate.)

When a serial communication link is established, the DataView® program will automatically identify the instrument that it is connected to. An instrument selection screen will appear for a few seconds while this takes place.

Once identification is complete, the Megohmmeter control panel, similar to below, will appear on the screen.

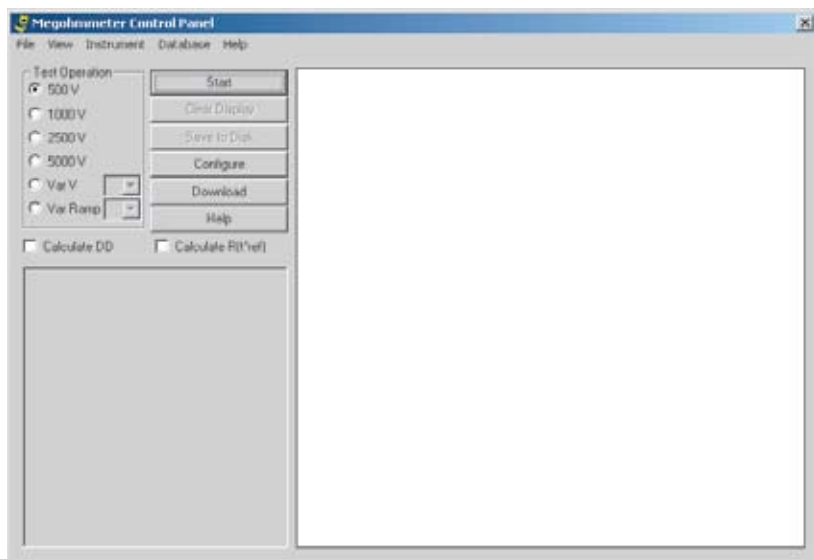

Figure 7-7

Click on the configure button to open the setup dialog box. There are four tabs in this dialog box. They are:

General Settings (Figure 7-8) - for programming the 5070's main functions

Variable Voltages (Figure 7-9) - for programming the three selectable voltages and their alarm set points

Ramp Voltages (Figure 7-10) - for programming the three ramp profiles

Temperature (Figure 7-11) - for programming the temperature correction variable

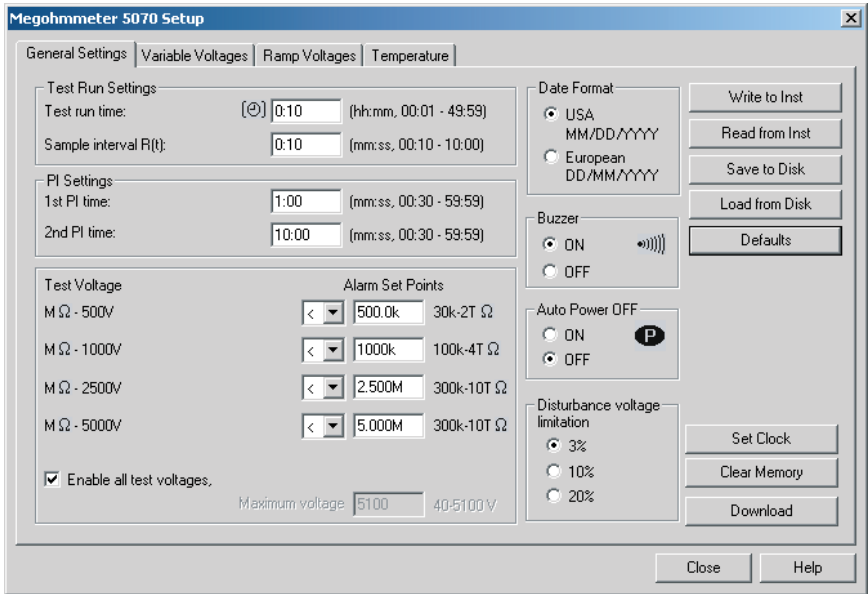

Figure 7-8

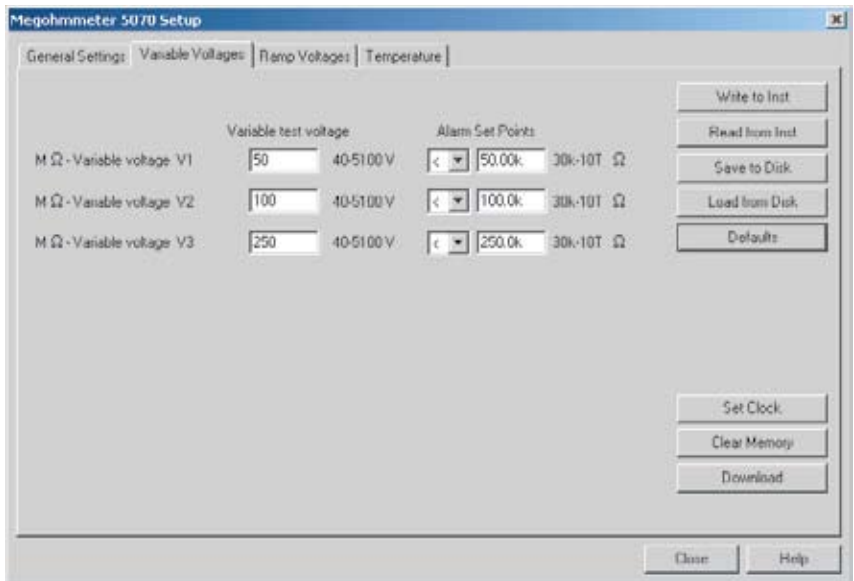

Figure 7-9

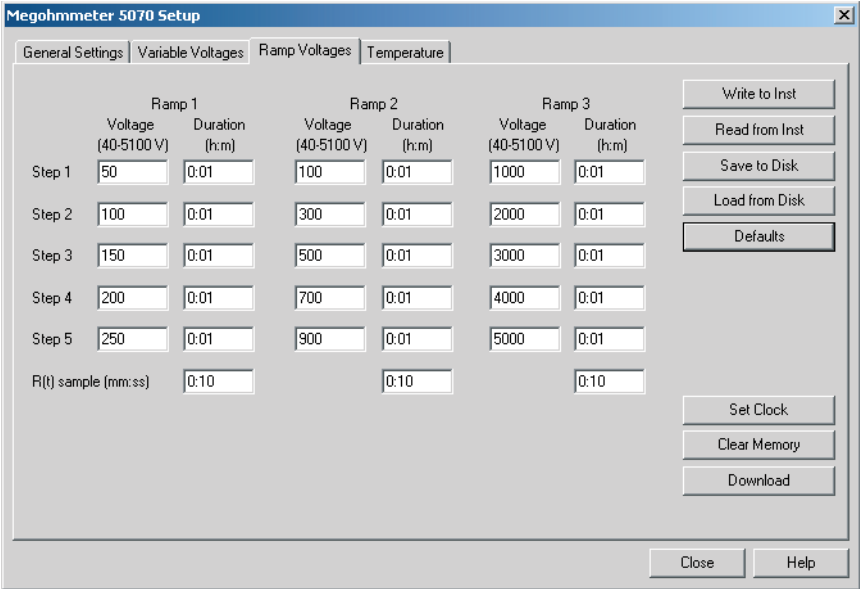

Figure 7-10

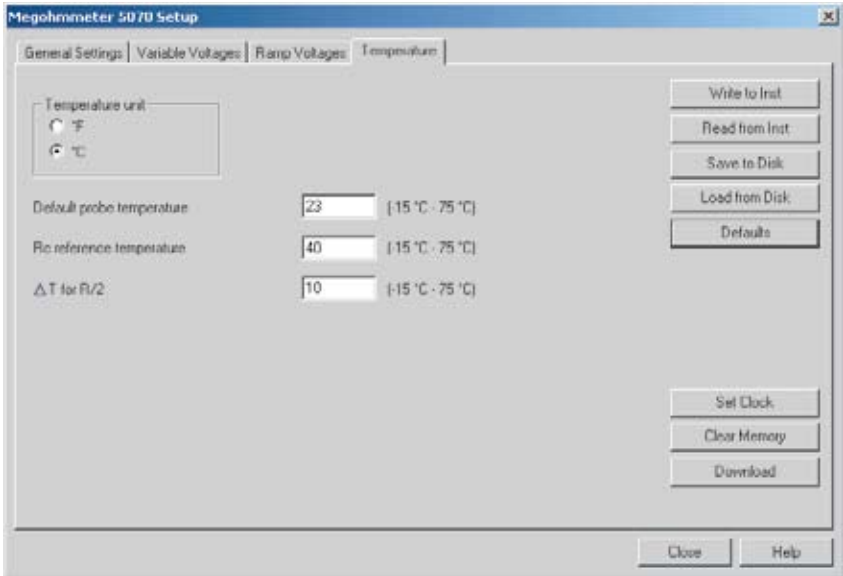

Figure 7-11

The Megohmmeter 5070 Setup dialog box lets you configure every aspect of the megohmmeter. Each field in the dialog box is identical to the programmable features available from the instrument front panel itself. Refer to Chapter 4 for a complete description of each configurable function.

Several of the functions are configured by typing the appropriate value in the field provided, such as test run time, which may be programmed from a value of one minute to 49 hours, 59 minutes.

Others are configured by clicking on the appropriate radio button, such as, activating or deactivating the buzzer by either selecting ON or OFF.

The right hand side of this setup dialog box contains eight command buttons:

- **Write to Inst:** Programs the megohmmeter using the current settings.
- **Read from Inst:** Reads the current configuration of the megohmmeter attached via the serial cable.
- **Save to Disk:** Saves the current configuration. This file will reside on the computer's disk drive. Saving different configuration setups can be useful for future functions and tests.
- **Load from Disk:** Retrieves a saved file from the computer's disk drive to be used in programming the megohmmeter.
- **Defaults:** Resets all fields in the Setup dialog box back to the original factory settings.
- **Set Clock:** Programs the computer's time and date into the configuration of the megohmmeter.
- **Clear Memory:** Erases all contents in all memory locations in the megohmmeter.
- **Download:** Retrieves the stored data from all memory locations within the megohmmeter for naming and storing on the computer's disk drive memory.

Once all fields in each of the 4 tabs of the Setup dialog box have been configured, it is recommended that you perform the following steps.

1. Click on the **Save** button.
2. Name and save the file.
3. Click on the **Write** button to configure the megohmmeter with this new configuration.
4. Click on the **Close** button to exit Setup and open the Control Panel.

7.6.2 Running the Test

After configuring the instrument (see § 7.6.1), the Control Panel will automatically open. The Control Panel is used to initiate a timed test from the computer.

There are five command buttons:

- **Start:** This button begins a timed test.
- **Clear Display:** Clears the statistical data, on the lower left side of the screen, and the graph, on the right side of the screen.
- **Save to Disk:** Saves the current data to a file in the computer.
- **Configure:** Returns to the megohmmeter Setup dialog box for configuring the instrument.
- **Download:** Retrieves data from the memory of the megohmmeter for storage in the computer.

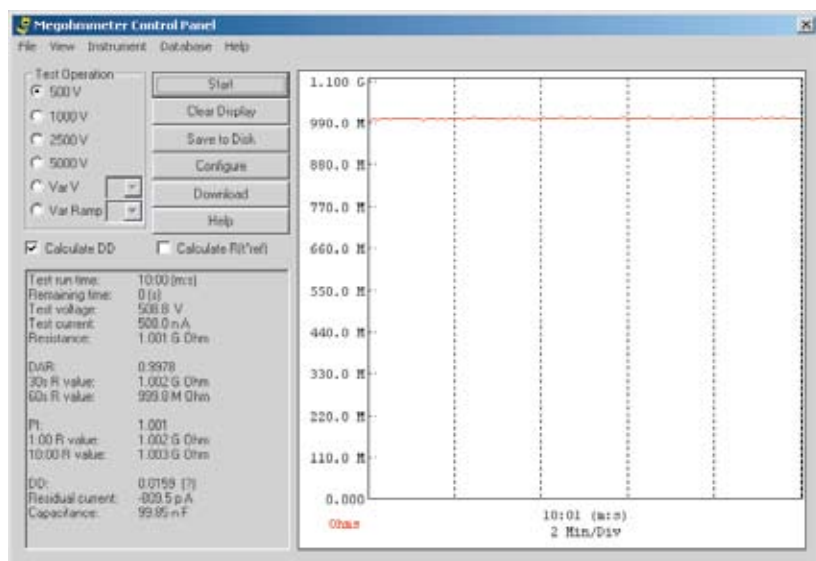

Figure 7-12

To run a timed test, perform the following steps:

1. Select the appropriate voltage for the test by clicking on one of the six radio buttons next to the desired selection. If VAR V or VAR RAMP is selected, you will also need to select profile 1, 2 or 3 using the drop-down arrow next to that selection.

2. Press the **Start** button. This will run the test at the selected voltage. As the test is running, all other buttons are grayed out and the **Start** button becomes a **Stop** button.

Once the test has started, a graph will begin to appear and build on the right side of the Control Panel (see Figure 7-12 and 7-13) representing a standard test and a step voltage test respectively.

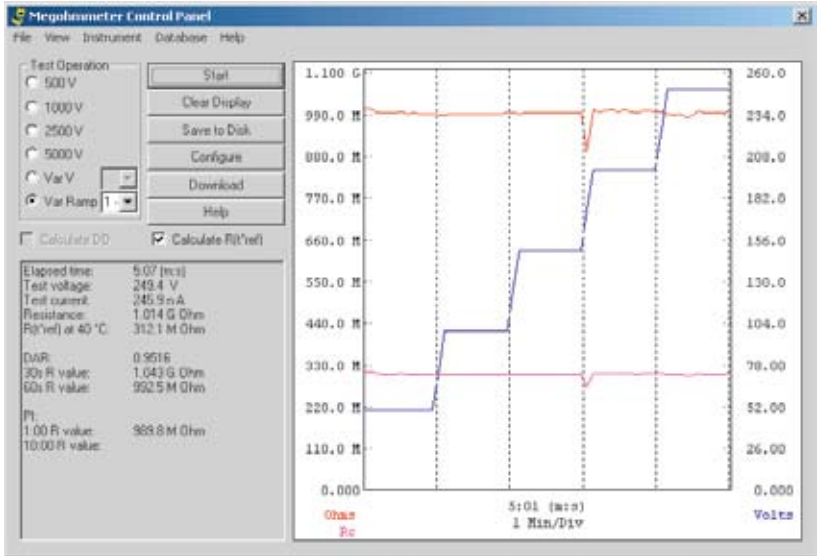

Figure 7-13

The statistical data for the time of the test, DAR, PI, resistance value and other information will appear as they are completed on the lower left side of the Control Panel.

The test will stop automatically at the end of the programmed run time. The test can be stopped at any time by pressing the **Stop** button. In either case, when the test is completed, the Model 5070 will automatically calculate dielectric discharge ratio if the calculate DD box is checked. This test takes 60 seconds.



NOTE: On small motors and machinery it is possible that the capacitance values are too low for this test to be completed accurately. In these cases, simply press the Stop button to stop the dielectric discharge test or uncheck this box before starting the test.

3. Once the test has been completed press the **Save to Disk** button to save the results of the test just completed to a disk drive in your computer.
4. Name the file in the dialog box that opens, then press the **Save** button.

This will open a session properties window (see Figure 7-14), which consists of the following:

- **Operator Information:** The information associated with the person and company conducting the test.
- **Site Information:** The information about the site itself.
- **Comments:** A place where information can be typed, such as, further descriptive analysis of the test, the test results, reasons for running the test, etc.
- **Make Default:** Saves the operator information into memory so that it will automatically appear the next time. This will save time on future tests.

The screenshot shows a 'Session Properties' dialog box with the following fields:

Section	Field	Value
Operator Information	Company:	AEMC Instruments
	Operator:	John Smith
	Address:	15 Faraday Drive
	City:	Dover
	State:	NH
	ZIP:	03820
	Phone:	
	Fax:	
	e-mail:	
Site Information	Company:	
	Contact:	
	Address:	
	City:	
	State:	
	ZIP:	
	Phone:	
	Fax:	
	e-mail:	

Buttons: OK, Cancel, Make Default

Figure 7-14

5. Once you have completed filling in all the information on the screen, press **OK**. This will open a dialog box allowing you to add a descriptive name for the object and test just performed. Type in any desired wording.
6. Press the **OK** button. The information is now saved to memory.
7. You will then be asked if you want to open the database just downloaded. Click the **Yes** button, which will open a dialog box labeled Create View from Template, similar to that shown in Figure 7-15.
8. The Megohmmeter Instrument Group and Megohmmeter 5070 Summary Report template will be selected automatically. If you wish to open the database using another template, then select it.

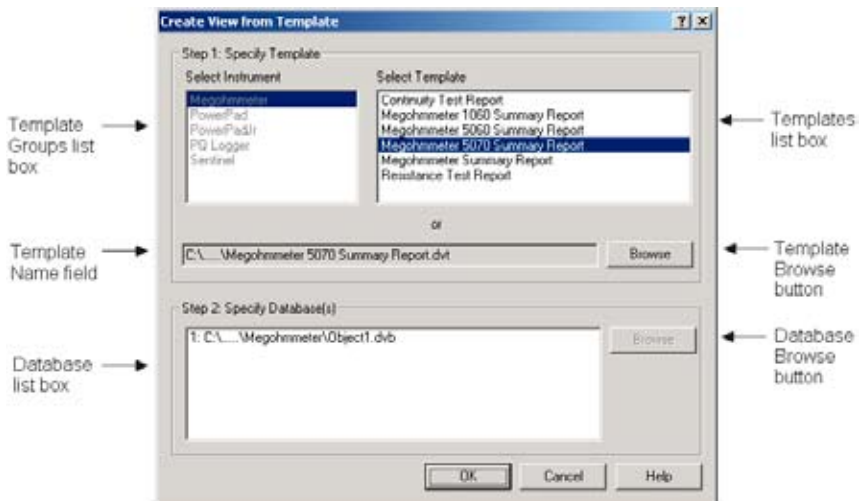

Figure 7-15

9. In the Step 2: Specify Database(s) window, the file you just saved and named should be visible. If this is the file you wish to generate a report from, click the **OK** button, if it is not, click on the file you wish to work with and then click **OK**. The report will now be available on the screen including graph, individual data points and all statistical data.
10. To print this report, either click on the Print icon or click on the File command and then Print.

7.7 DataView® Megohmmeter Templates

7.7.1 Megohmmeter Summary Report Template

This template generates a view with two worksheets. Each worksheet is selected via the Worksheet tabs located just above the status bar.

An example of the first worksheet is shown below.

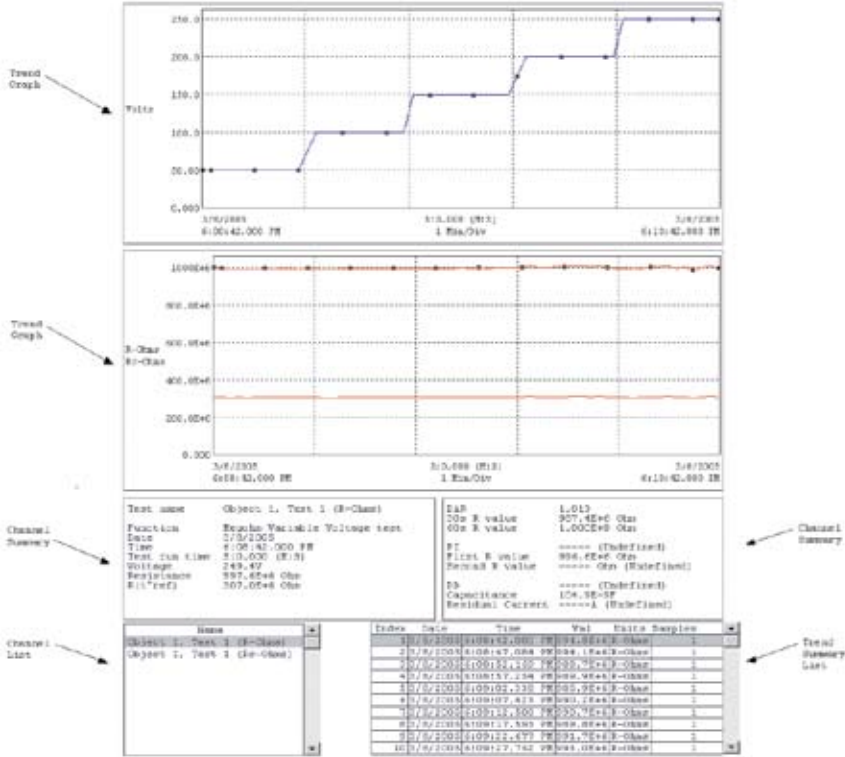

Figure 7-16

This worksheet contains the following frames:

- **Trend Graph:** This frame provides a graphical look into the database it is attached to. The database is attached to the Trend Graph Frame when it is created.
- **Channel Summary:** This frame displays a textual summary of the channel record (trace) selected in its parent frame.
- **Channel List:** This frame displays a textual summary of the channel records contained in the database attached to its parent frame.

- **Trend Summary List:** This frame displays a textual list of the sample points for a given test. Each summary line contains user-specified parameters of a group of sample points.

The results for each test is displayed by selecting the desired test from the Channel List. When a test is selected the graph, channel summary, and trend summary frames are updated to display the values for the selected test.

7.7.2 Title Page

An example of the second worksheet is shown below. This is the title page for the report. It will contain all of the information you entered in the session properties box when saving the data.



Figure 7-17

This worksheet contains the following frames:

- **Title Box** - containing the text “Trend Summary Report”
- **Operator Summary** - containing operator information
- **Site Summary** - containing test site information
- **Comments Summary** - containing typed in operator comments
- **Database** - containing the name of the database used to generate the report

Each of these frames is customized by using the associated properties dialog box. The properties dialog box for a frame is displayed by selecting the frame, right-clicking and selecting **Properties** from the list displayed.

MAINTENANCE

Use only factory specified replacement parts. AEMC® will not be held responsible for any accident, incident, or malfunction following a repair done other than by its service center or by an approved repair center.

8.1 Recharging the Battery

If the  symbol is flashing, the battery needs to be recharged.

Connect the instrument to the 120VAC power cord via the connector (charging starts automatically even if the instrument is turned off).

- **If the instrument is charging in the OFF position:** the battery symbol is displayed and the 3 bars flash throughout the charging - “Charging battery” is also indicated. When the battery is full, the symbol and its 3 bars are lit steadily and “Charging Full” is indicated.
- **If the instrument is charging in a measurement position:** the battery symbol flashes. There is no full charge indication. The “Charging Full” indication is displayed only when the instrument is returned to the OFF position.

If the instrument is turned on and the battery voltage is $>8V$, then the normal use of the device is permitted.



NOTE: The battery should be changed by an authorized repair facility recognized by AEMC® Instruments.



WARNING: Changing the battery causes data to be lost from the memory.

Press the **MEM/MR** button (“**OFF**” is displayed). Proceed with a total clearing of memory in SET-UP (see §4.8) so the MEM/MR functions can be used again.

8.2 Fuse Replacement

If **GUARD FUSE** appears on the display, the fuse must be replaced, taking all the necessary precautions when opening up the instrument.



WARNING: Make sure that none of the terminals are connected and that the selector switch is set to the OFF position before opening up the case.

Only use the type of fuse shown on label inside the unit's cover:

0.1A - Fast Acting - 380V, 5x20mm, 10kA (**Cat. #2119.84**)

8.3 Cleaning



WARNING: Disconnect the instrument from any source of electricity.

- Use a soft cloth lightly dampened with soapy water. Rinse with a damp cloth and then dry with a dry cloth.
- Do not get water inside the case. This may lead to electrical shock or damage to the instrument.
- Do not use alcohol, solvents or hydrocarbons.

8.4 Storage

If the instrument is not used for an extended time period (longer than two months), it is recommended that a complete charge and discharge of the battery is performed three times before re-using the instrument.

Complete battery discharge can be performed:

- By removing the battery from the instrument and applying a 3 Amp load to it.
- On the 5000V position with the backlight on (consumes the most power)

APPENDIX A

UTILIZING THE GUARD TERMINAL

- Guard terminals are useful when measuring high resistance values and for stabilizing readings.
- Surface leakage is fundamentally a low resistance path in parallel with the most important resistance path through the body of the insulation. The guard terminal can be used to stop the effects of the surface leakage from influencing the measurement of resistance through the insulation. In the example of a cable, shown in the diagram below, connecting the guard terminal of the Model 5070 to the surface of the insulation will redirect surface leakage currents away from the true measured value of leakage current from the conductor through the insulation.
- The use of the guard terminal is most important when there is a significant exposed surface in a cable. When testing the insulation at the end of a cable, it is necessary to eliminate the error from surface leakage which occurs, particularly at high resistance values. The guard terminal provides a third terminal within the path of the surface leakage. Connect the instrument as shown in Figure A-1.

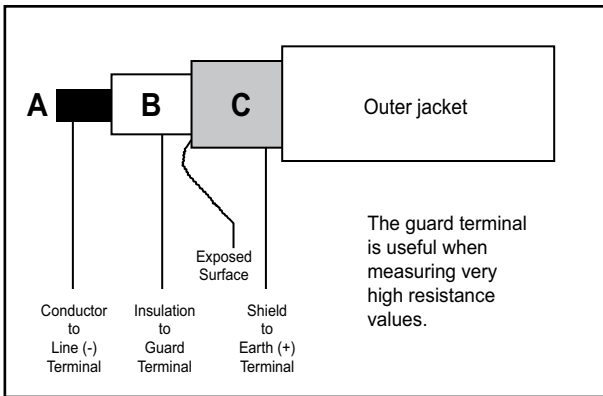

Figure A-1 - Shielded Cable

- Connect the black (-) test lead to the conductor at A
- Connect the red (+) test lead to the shield layer of the cable at C
- Connect the blue Guard (G) lead to the insulation layer of the cable at B

If there is no shield, use a copper wire wound several times around the exposed

surface. (Note: If a shield is not available and you do not make up a shield around "B" and connect to the guard terminal (-), the measurement will be erroneous and lead to confusion as to the cable's condition). If the guard terminal is not connected at "B", the instrument measures the current "i" flowing through the insulation and a surface leakage current "i₁". See Figure A-2.

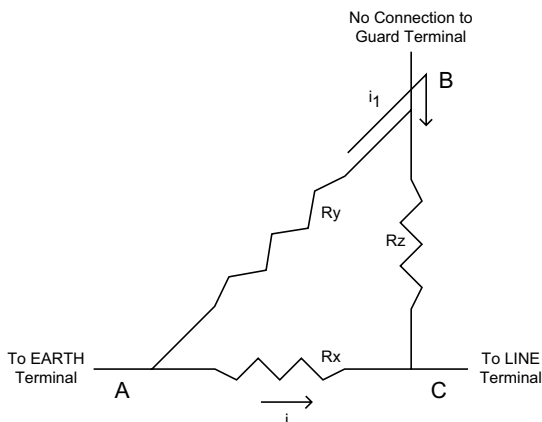

Figure A-2 - No Guard Terminal Connected

With the guard terminal connected, the surface leakage i_1 is removed and has no effect on the reading, See Figure A-3.

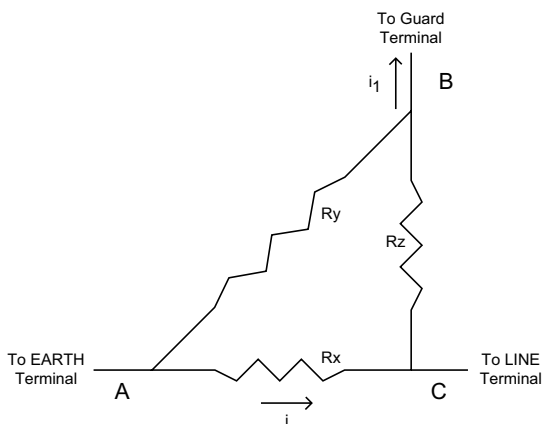

Figure A-3 - Guard Terminal Connected

APPENDIX B

SERIAL CABLE REQUIREMENTS

RS-232 Specifications

The Baud Rate can be set to 300, 600, 1200, 2400, 4800, 9600, or “Parallel” (for printing results on parallel printers via the optional serial-to-parallel adapter) in the **SET-UP** mode (see § 4.1).

The Data format is: 8 data bits, 1 stop bit, no parity, Xon / Xoff protocol.

Serial Printer Connection

Cable, PC RS-232, DB9 F/F 6 ft (for serial printer) **Cat. #2119.46**

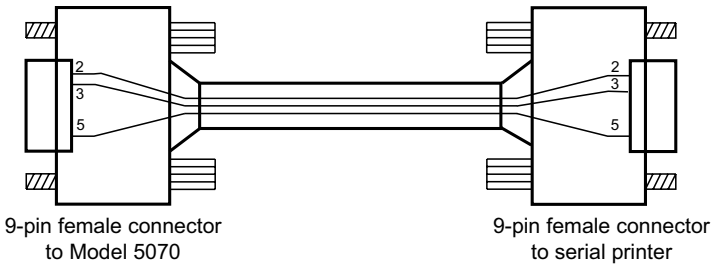

Connection to a PC or to a Parallel Printer

Cable, PC RS-232, DB9 F/F 6 ft Null Modem Cable **Cat. #2119.45**

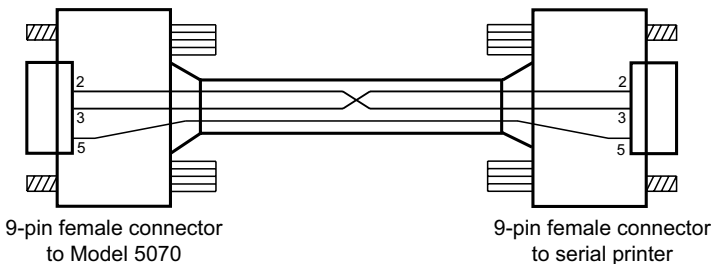

APPENDIX C

V DISTURBANCE/V OUTPUT FEATURE

The V Disturbance/V Output feature (referred to in the text of this manual as dISt) serves two purposes.

First it acts as a safety device inhibiting the instrument from generating a test voltage when live signals are present.

In the set up mode, you can choose a percentage of the test voltage that constitutes a condition that requires the test to be inhibited before it starts. If the Model 5070 measures a voltage higher than the V Disturbance/V Output setting allows, no test voltage will be generated when the Start button is pressed.

The calculation for this condition is simple. In the set up mode, you have a choice to set the ratio for V Disturbance/V Output (stated as dISt) to 3, 10 or 20%. The inhibit voltage is then calculated by multiplying this percentage times the test voltage.

Example: Test voltage is set to 500 and the V Disturbance/V Output is set to 3% therefore the voltage present at the input terminals before the start of a test that will inhibit testing is $(500)(0.03) = 15$ volts. The table below shows the inhibit voltages for the 4 fixed test voltage positions and the three V Disturbance/V Output percentages.

Before Testing

Test	V Disturbance/V Output		
Voltage	3%	10%	20%
500	15	50	100
1000	30	100	200
2500	75	250	500
5000	150	500	1000

If a sudden change in voltage occurs during the test, the formula for calculating V Disturbance/V Output is slightly different. It is $(V \text{ Output})(1.05 + dISt)$. Using 500 volts as the test voltage and 3% as dISt, the inhibit voltage that must occur after a test is started is $(500)(1.05 + .03) = 540$ volts. The table below shows the inhibit voltages for the 4 fixed test voltage positions and the three V Disturbance/V Output percentages that must occur after a test starts.

During a Test

Test	V Disturbance/V Output		
Voltage	3%	10%	20%
500	540	575	625
1000	1080	1150	1250
2500	2700	2875	3125
5000	5400	5750	6250

Repair and Calibration

To ensure that your instrument meets factory specifications, we recommend that it be scheduled back to our factory Service Center at one-year intervals for recalibration, or as required by other standards or internal procedures.

For instrument repair and calibration:

You must contact our Service Center for a Customer Service Authorization Number (CSA#). This will ensure that when your instrument arrives, it will be tracked and processed promptly. Please write the CSA# on the outside of the shipping container. If the instrument is returned for calibration, we need to know if you want a standard calibration, or a calibration traceable to N.I.S.T. (Includes calibration certificate plus recorded calibration data).

Ship To: Chauvin Arnoux®, Inc. d.b.a. AEMC® Instruments
15 Faraday Drive
Dover, NH 03820 USA
Phone: (800) 945-2362 (Ext. 360)
(603) 749-6434 (Ext. 360)
Fax: (603) 742-2346 or (603) 749-6309
E-mail: repair@aemc.com

(Or contact your authorized distributor)

Costs for repair, standard calibration, and calibration traceable to N.I.S.T. are available.

NOTE: You must obtain a CSA# before returning any instrument.

Technical and Sales Assistance

If you are experiencing any technical problems, or require any assistance with the proper operation or application of your instrument, please call, mail, fax or e-mail our technical support team:

Chauvin Arnoux®, Inc. d.b.a. AEMC® Instruments
200 Foxborough Boulevard
Foxborough, MA 02035 USA
Phone: (800) 343-1391
(508) 698-2115
Fax: (508) 698-2118
E-mail: techsupport@aemc.com
www.aemc.com

NOTE: Do not ship Instruments to our Foxborough, MA address.

Limited Warranty

The Megohmmeter Model 5070 is warranted to the owner for a period of one year from the date of original purchase against defects in manufacture. This limited warranty is given by AEMC® Instruments, not by the distributor from whom it was purchased. This warranty is void if the unit has been tampered with, abused or if the defect is related to service not performed by AEMC® Instruments.

For full and detailed warranty coverage, please read the Warranty Coverage Information, which is attached to the Warranty Registration Card (if enclosed) or is available at www.aemc.com. Please keep the Warranty Coverage Information with your records.

What AEMC® Instruments will do:

If a malfunction occurs within the one-year period, you may return the instrument to us for repair, provided we have your warranty registration information on file or a proof of purchase. AEMC® Instruments will, at its option, repair or replace the faulty material.

REGISTER ONLINE AT: www.aemc.com

Warranty Repairs

What you must do to return an Instrument for Warranty Repair:

First, request a Customer Service Authorization Number (CSA#) by phone or by fax from our Service Department (see address below), then return the instrument along with the signed CSA Form. Please write the CSA# on the outside of the shipping container. Return the instrument, postage or shipment pre-paid to:

Ship To: Chauvin Arnoux®, Inc. d.b.a. AEMC® Instruments
15 Faraday Drive • Dover, NH 03820 USA
Phone: (800) 945-2362 (Ext. 360)
(603) 749-6434 (Ext. 360)
Fax: (603) 742-2346 or (603) 749-6309
E-mail: repair@aemc.com

Caution: To protect yourself against in-transit loss, we recommend you insure your returned material.

NOTE: You must obtain a CSA# before returning any instrument.

Notes:



06/07

99-MAN 100283 v10